

Nauatlajtoli

*Lengua náhuatl
Tehuacán, Puebla*

Primer grado



NOMBRE DEL ALUMNO (A)

ESCUELA

GRUPO

POBLACIÓN

ENTIDAD FEDERATIVA

Este libro de texto ha sido elaborado por el Gobierno de la República y se entrega en forma gratuita a los niños de las escuelas primarias del país.

Los juicios y opiniones de los maestros, de los padres y de los alumnos son muy importantes para mejorar la calidad de este libro. Sus comentarios pueden ser enviados a la siguiente dirección:

COMISIÓN NACIONAL DE LIBROS DE TEXTOS GRATUITOS

Rafael Checa núm. 2 col. Huerta del Carmen
C.P. 01000, México, D.F.

Las obras de arte que ilustran las cubiertas de los libros de texto gratuitos son representativas de las grandes etapas del arte mexicano. Constituyen un valioso respaldo educativo y son motivo de orgullo nacional.

SEP

Libro de texto en lengua náhuatl de Tehuacán, Puebla.

Elaborado en la Dirección General de Educación Indígena de la Subsecretaría de Educación Básica de la Secretaría de Educación Pública

Autor

María Antonia Orlanda Rojas Alta

Ilustración

Jaime García y José Luis López

Fotografía

Archivo Iconográfico de la Dirección General de Educación Indígena y Carlos Ramos Trejo

Diseño de Portada

Comisión Nacional de Libros de Texto Gratuitos, con la colaboración de Luis Almeida

Ilustración de Portada

“Vendedora de frutas”, Olga Costa (1913-1993)

Óleo sobre tela, 1951, 195 x 245 cm.

Museo de Arte Moderno, INBA, CNCA

Reproducción autorizada por el Instituto Nacional de Bellas Artes y Literatura

Fotografía de Portada

Javier Hinojosa

D.R © Ilustración de Portada: Olga Costa /INBA

D.R © Secretaría de Educación Pública, 1996

Argentina No. 28

Col. Centro, C.P. 06029

México, D.F.

ISBN 978-968-29-9856-0

Primera edición 1996

Décima sexta reimpresión 2013

Impreso en México



La Patria (1962),
Jorge González Camarena.

Esta obra ilustró la portada de los primeros libros de texto. Hoy la reproducimos aquí para que tengas presente que lo que entonces era una aspiración: que los libros de texto estuvieran entre los legados que la Patria deje a sus hijas y a sus hijos, es hoy una meta cumplida.

A seis décadas del inicio de la gran campaña alfabetizadora y de la puesta en marcha del proyecto de los libros de texto gratuitos, ideados e impulsados por Jaime Torres Bodet, el Estado mexicano, a través de la Secretaría de Educación Pública, se enorgullece de haber consolidado el principio de la gratuidad de la educación básica, consagrada en el Artículo Tercero de nuestra Constitución, y distribuir a todos los niños en edad escolar los libros de texto y materiales complementarios que cada asignatura y grado de educación básica requieren.

Los libros de texto gratuito son uno de los pilares fundamentales sobre los cuales descansa el sistema educativo de nuestro país, ya que mediante estos instrumentos de difusión del conocimiento se han forjado en la infancia los valores y la identidad nacional. Su importancia radica en que a través de ellos el Estado ha logrado, en el pasado, acercar el conocimiento a millones de mexicanos que vivían marginados de los servicios educativos y, en el presente, hacer del libro un entrañable referente gráfico, literario, de conocimiento formal, cultura nacional y universal para todos los alumnos. Así, cada día se intensifica el trabajo para garantizar que los niños de las comunidades indígenas de nuestro país, de las ciudades, los niños que tienen baja visión o ceguera, o quienes tienen condiciones especiales, dispongan de un libro de texto acorde con sus necesidades. Como materiales educativos y auxiliares de la labor docente, los libros que publica la Secretaría de Educación Pública para el sistema de Educación Básica representan un instrumento valioso que apoya a los maestros de todo el país, del campo a la ciudad y de las montañas a los litorales, en el ejercicio diario de la enseñanza.

De esta forma, el libro ha sido, y sigue siendo, un recurso tan noble como efectivo para que México garantice el Derecho a la Educación de sus niños y jóvenes.

Nauatlajtoli

*Lengua náhuatl
Tehuacán, Puebla*

Primer grado



PRESENTACIÓN

Este libro de texto está dirigido a las niñas y los niños indígenas que cursan la educación primaria, tiene el propósito de favorecer el aprendizaje de la lectura y la escritura de la lengua indígena que se habla en su comunidad.

Se espera que este libro sea utilizado en forma creativa, tanto por el profesorado como por las niñas y los niños, en este ciclo escolar y los subsecuentes, para dar respuesta a los problemas particulares que se presenten en el desarrollo de la expresión escrita y la comprensión lectora.

En el libro se encuentran diferentes textos, algunos hablan del entorno físico de los alumnos, objetos y cosas que hay en la comunidad, y otros se refieren al entorno social y cultural, pues relatan las costumbres, fiestas y leyendas de la región.

Su elaboración estuvo a cargo de profesores indígenas bilingües con experiencia en la enseñanza de su lengua materna así como con profundo conocimiento de la cultura de sus comunidades. Para la redacción, los autores consideran el enfoque comunicativo propuesto en el *Plan y Programas de Estudio para la Educación Primaria 1993*.

Este libro de texto podrá ser enriquecido a partir de las observaciones y consideraciones que profesores, padres de familia, comunidades y organizaciones civiles indígenas realicen acerca del lenguaje utilizado, los contenidos, las ilustraciones, el formato y la presentación.

TLAIXPANTILISTLI

Ni amochtli tlen maseuattlajtoli, kiuka iyejyekol tlen se xiuitt tlamachtlistli koneme kiselia ipan chikuase xiuitt, mochiua pampa moneki makualli kixpouaka iuan kijkuiloka imaseuattlajtol. Ijkuak; se konettl kixtlamachtia ika imaseuattlajtol okachi totoka kitilia pampa ika ye tlajtoli motlapouia.

Ni amochtli okichijke maseuattemachtijke akin kipia miek xiuitt tekpanojtoko iuan koneme iuan kipia miek ixtlamatijkayotl ika intlajtol iuan inemilis. Omochi ika itlanauatitl amatlayekanketl tlen chikuase xiuitt tlamachtijkayotl tlen okiski ipan naui tsonitl iuan kaxtoli iuan naui pouali iuan majtlaktli iuan eyi xiuitt, ijko tejua tikpia se yenkuik amatlajkuiloli tlen kineki koneme ijtik kalltamachtlistli, ijko yau nochi tlaixmatijkayotl ipan tlamachtlistli yejo tlen kineki ye tlanauatitl tlen yenkuik tlamachtlistli.

Ni amochtli tilayejyekoli uelitis mopattlatias, achto moneki motekipanos itech kalltamachtlistli iuan uelitis moyektialis tlamonekilis. Omejua onkoneme iuan omoixtamachiis kijos.

Nochi tlen kijoske yejua temachtijke, tetajme, atepeme iuan okseki tlanechikolmaseuattlakeme tikinkakiliske iuan tikyekchiuske ni amochtli.

Tikintlasojkamattilia miek nochtli maseuattemachtijke, nochtli maseuattlayekanke iuan tetajme tlen iuan otikitake ni amochtli tlen se xiuitt tlamachtlistli tlen omochi ika maseuattlajtoli iuan nika omottali nochi omoixtamattilis.



República

Mexicana

Golfo de México

Océano Pacífico



GOLFO
DE
MÉXICO

HIDALGO

VERACRUZ

ESTADO
DE
MÉXICO

TLAXCALA

PUEBLA

(Kuetlaxkoapa)

MORELOS

GUERRERO

OAXACA

- Nicolás Bravo
- Santiago Miahuatlán
- Tehuacán
- Altepexi
- Zapotitlán Salinas
- San Gabriel Chilac
- Caltepec
- San José Miahuatlán
- San Antonio Cañada
- Ajalpan
- Zoquitlán
- Coxcatlan
- San Sebastian Zinacatepec
- Eloxochitlán (El mirador)
- Tlacotepec de Díaz
- Coyomeapan
- Vicente Guerrero

TLAJTOLPEUALI

AMATLAXELOLI

TOKAYOTL

ISUATL

1

ACHTOPA AMATLAXELOLI
KALCHANEJKE

13

2

OJPA AMATLAXELOLI
Itlaixnextilis ixtlauak
Altepeko

57

3

EIXPA AMATLAXELOLI
Nochi tlen techyualoua

93

4

NAUJPA AMATLAXELOLI
Totlaixmatijkayotl

133

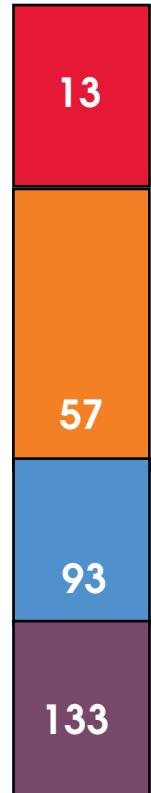

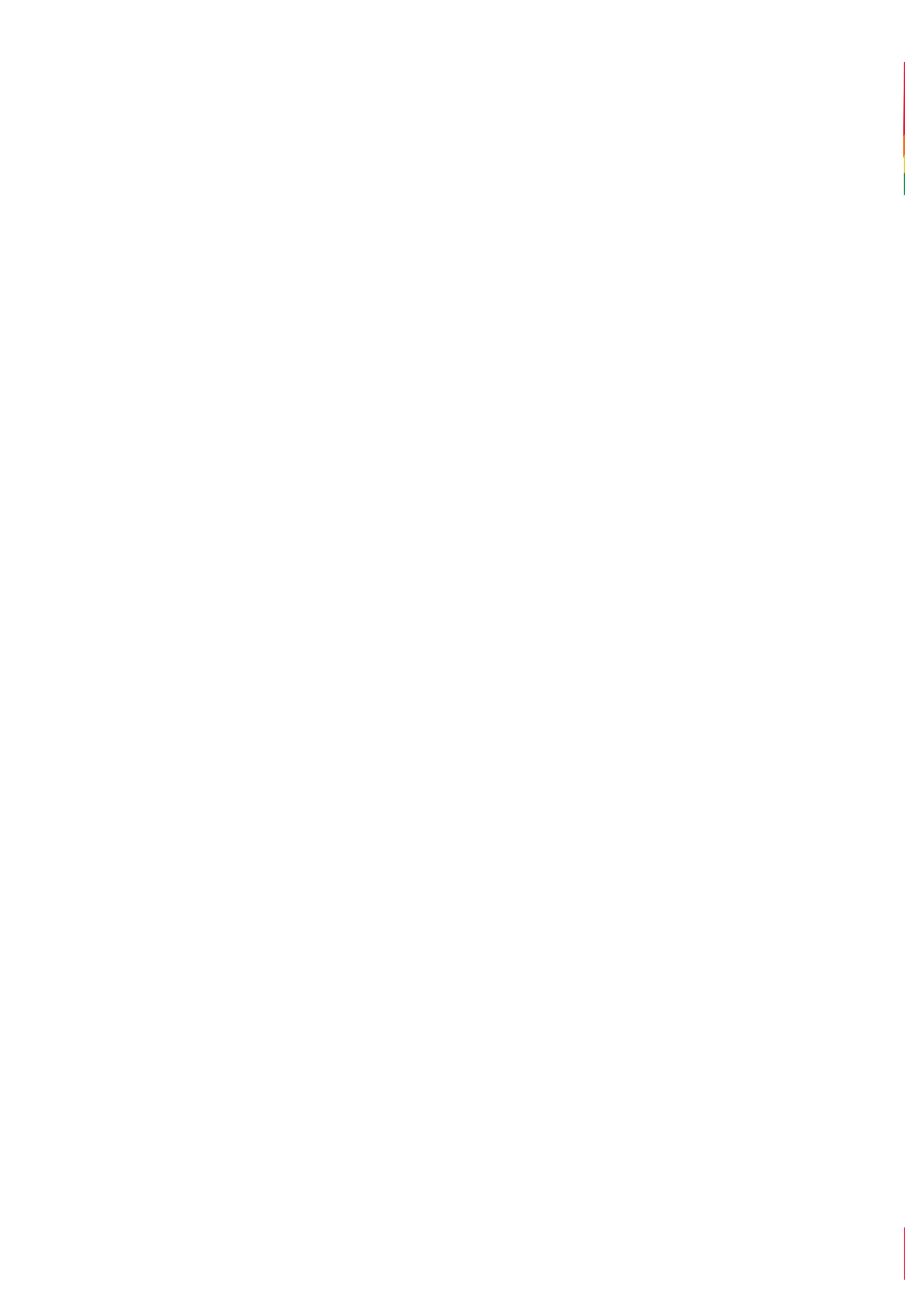

ACHTOPA AMATLAXELOLI



Kalchcnajke.

Nochi tlen kichiua kalchanejke.







KALPALEUILISTLI

Tejua tinauatlajtoani, nohti tlen tichanti itech sekali timosenpaleuia pampa uelitis timonekuitlause. Tokojkoltsi pampa amo okixikoua kitekipanos tlali ye kintlamaka yolkame tlen kate itech kali kenomi: piome, itskuinti, iuan mistome. Tositsin ye kimita ixuitsitsiua tlen okachi tsitsinti; totajtsin ye kitekipanoua tlali; tonantsin ye tlakualchiua iuan tiaxkaloua; iknime tlen okachi uejuei tapaleuia, ichpokame kipaleuia inantsin iuan teipokame itajtsin.



tata



nana



iknitl



uelti



sitsintli



kojkoltsin



Nana iuan tata yau i mila elotekitiui.



Ikname kauiltia se taktli.



Kojkoltsi iuan sitsintli moseuia iuan motlapouia.

Ipan ni tlatsakuali, xiktlali motlaixnextilis.

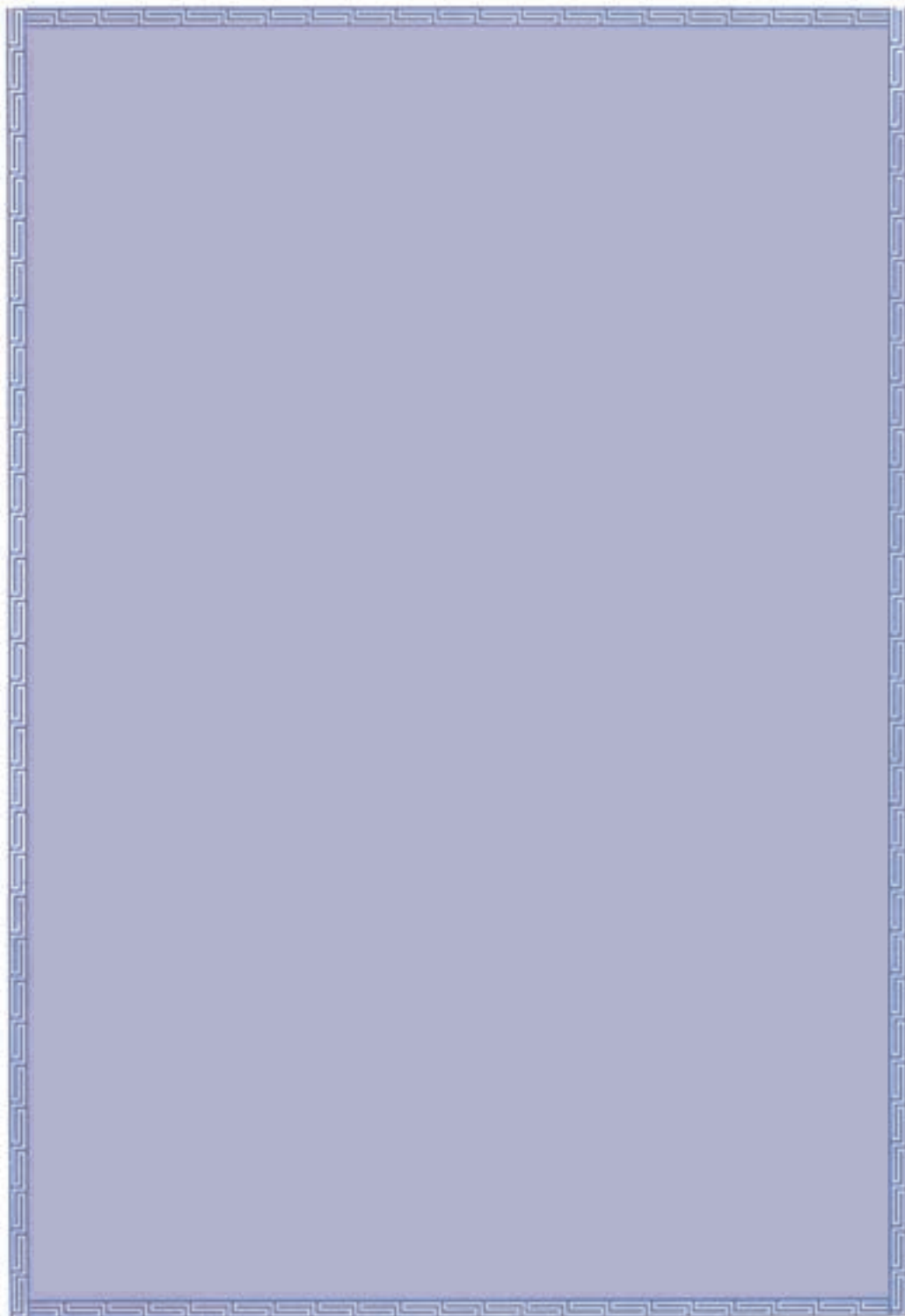

Ipan ni tlatsakuali, xiktlali ye
intlaixnextilis motataua.

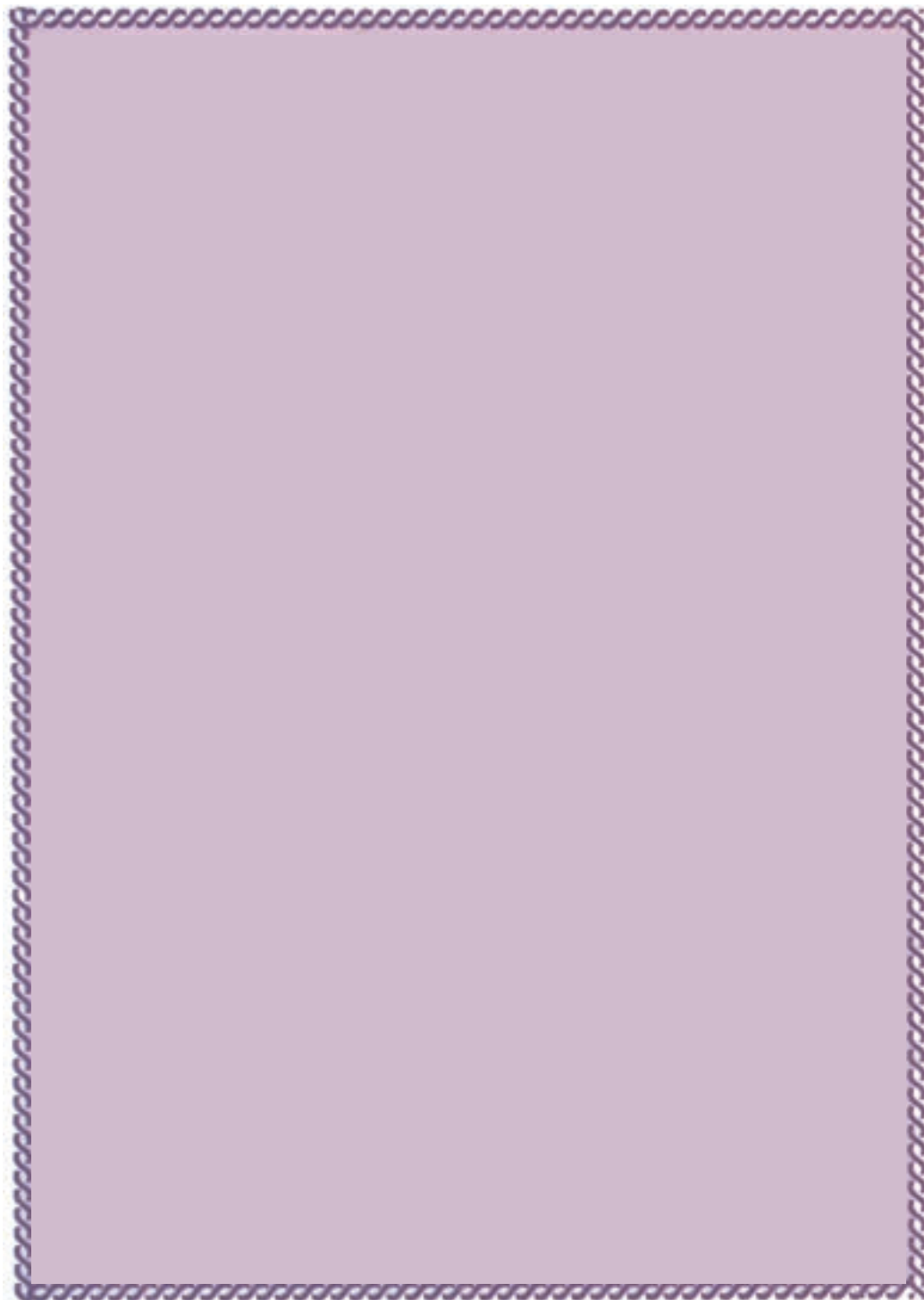



KANIN CHANTI NOSITSI

Kanin chanti nositsi, onka miek xochitl. Nositsi kinpia mieke yolkame; ye kintlamaka kualka; kinmaka atl, tlayoli uan xiuitl. Nositsi, tlaxkaloua iuan kichijchiua miek atoli pampa kiuelita techmakas.



Tlen onka kalijtik.



Tlen onka Kaltempa.

**Ximotlapoui iuan oksekime koneme tlen
onkita ipan nime flatsakualme.**





TLAPIXKALO (Tlakuikali)

Kema kualtsi kajki mila
xochitonal yaualitok
kani kajki nonanantsi
kuechojtika inextamaltsi
tolontsi tlan chia tikuas
tolontsi ye tlan tiktokas.

Tlatikneki ye pixkalos achto
timitonis te
totome onechititijke
san kualkantsi tlakuikalotl
kani kajki nonanantsi
kuechojtika inextamaltsi.

Temachtijketl
Elizabeth Negrellos

Xikita kenomi kajki mili ijkuak yikin peua kisa, ijkuak yomoskalti iuan ijkuak youaki.

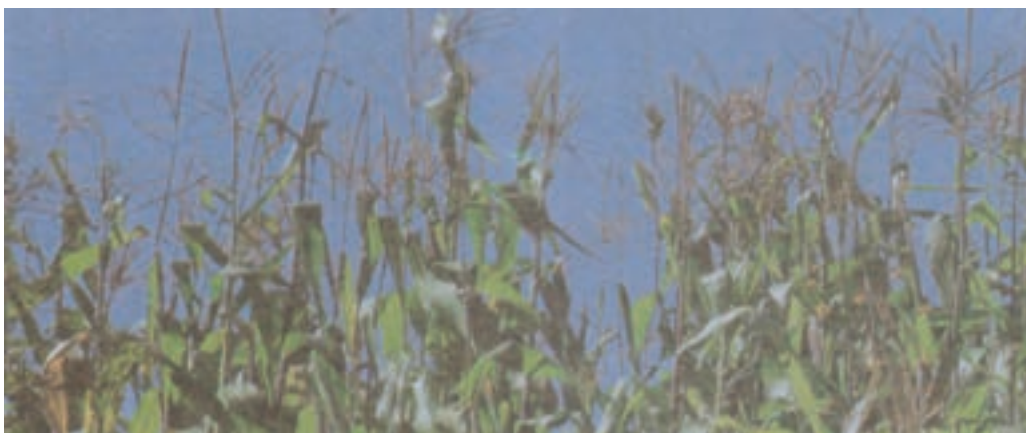

**Ximotlapoui iuan oksekime koneme tlen
onkikua onmokalijtik.**



tlaxkali



nanakatl



kakauatl



xonakatl



atoli



pionakatl

Mamitspaleui omotemachtli iuan xiksetili
ouatl iuan michintsi ika se pitsakmekatl.

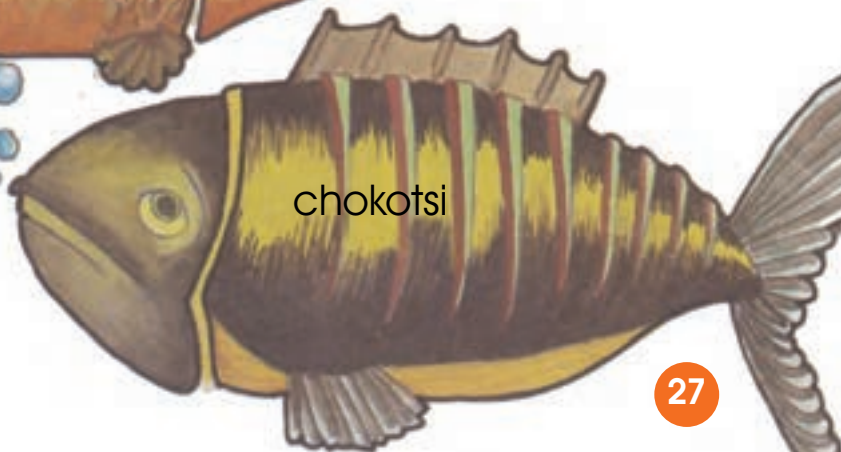
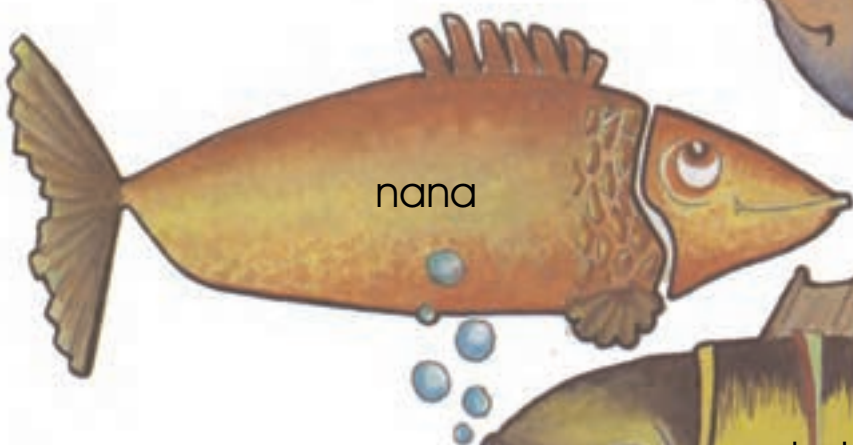
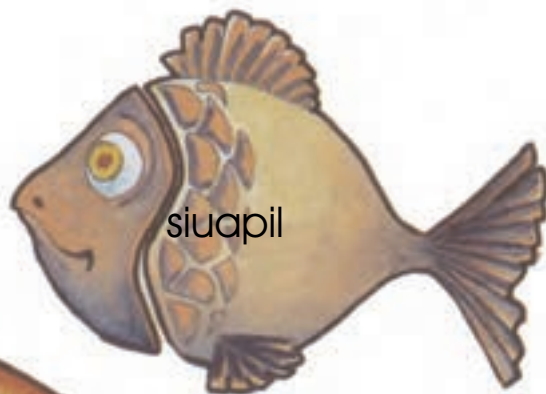
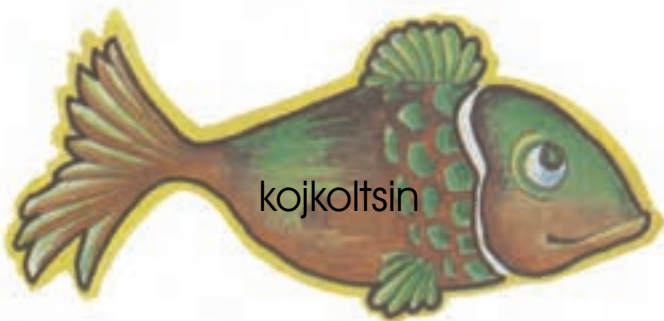
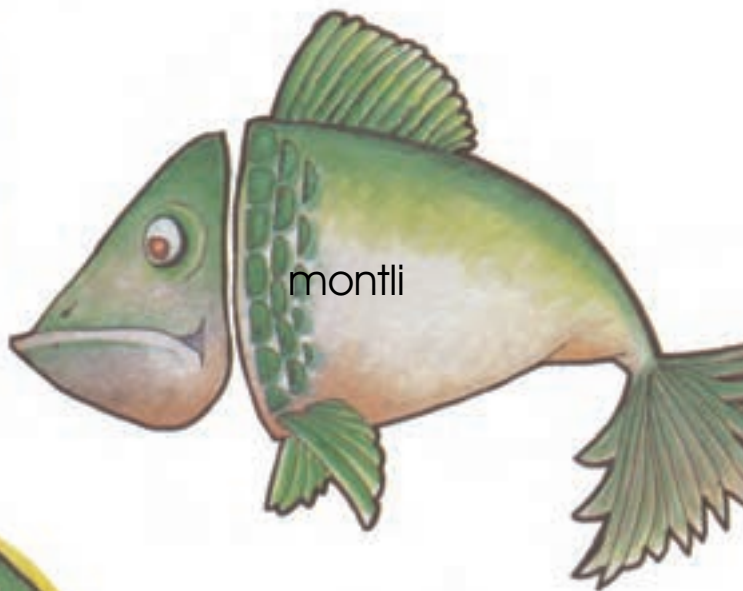

Xikintlalili intoka tlalchi kanin kate koujtsitsinti.





Xikijto akin yau'i tlayekapa iuan akin tlakuitlapa.



Xikijto akin okachi uejkapa: ye takotsi noso ye chokotsi.



KALCHANEJKE

Mopoua okatka sekime kalchanejke, iuan semijjak omokualaniaya, iuan se kimichi okinkakiaya -iuan okijto ye iselti- akin

peuas mokualanis ijkuak yotlayouak iuan yikochtoke ne nias iuan nikualis inyekatsol; iuan ijko okichi ijko opanoke tonalti iuan nohti okinkuali inyekatsol iuan kalchanejke sanima okiyejyekojke nikokinkuali iyekatsol pampa omokualaniaya.

Ijkuak yejua okimopantijke, amo oksemi omokualanijke.

Nika tiami ni tlapouali.

**Ijtik ni tlatsakuali xikimixnexti nohti tlen
chanti mokalijtik iuan ipan koujtsitsinti
xikintlali intoka.**

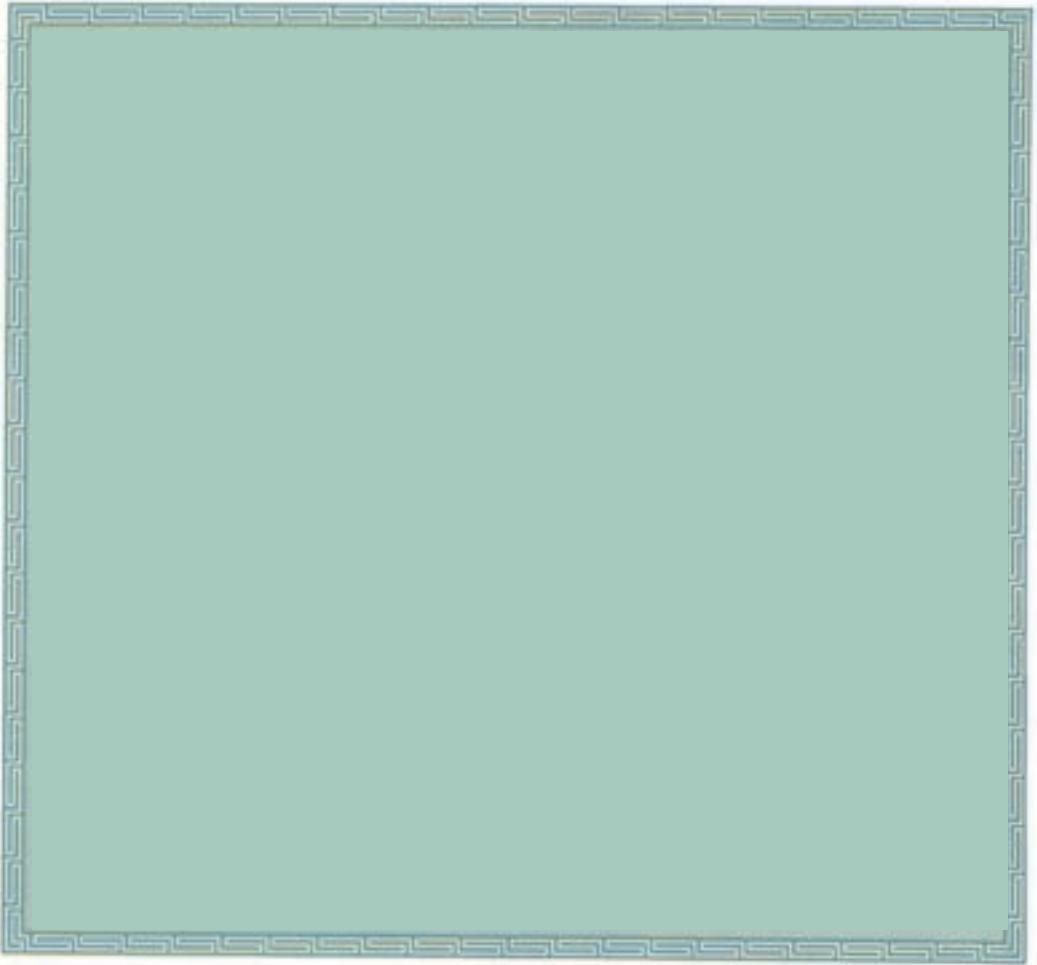

Xikijkuilo ipan koujtsitsinti nochi tlen tikita ipan tlatsakualme.







Itech kouitl kate intoka nochtl
tlaixnextilme tlen kate tlalchi; xikinpanolti
ipan koujtsitsinti.

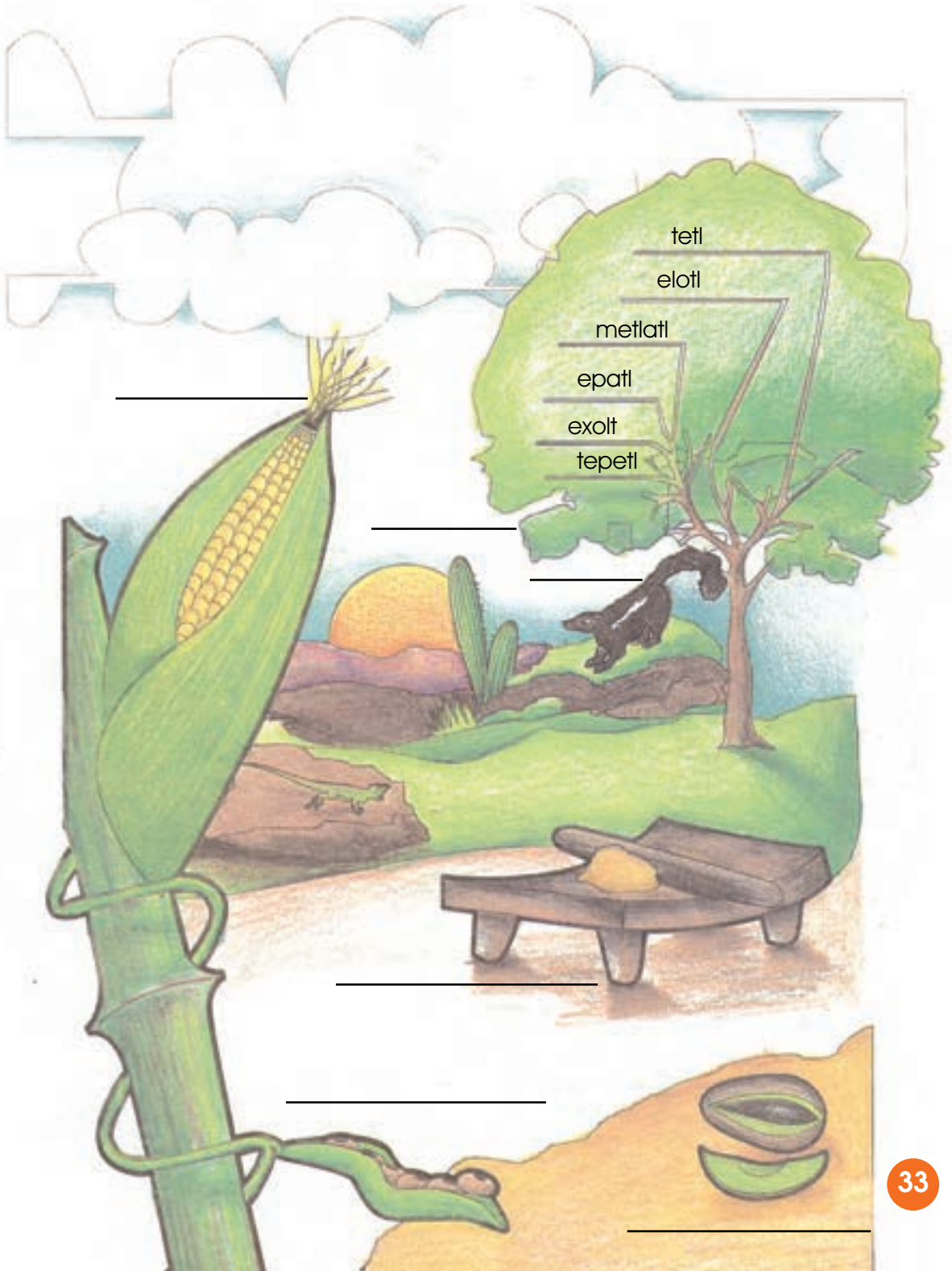

Ipan koujtsitsinti xikintlalili intoka
tlaixnextilme tlen kate itech kouatl.



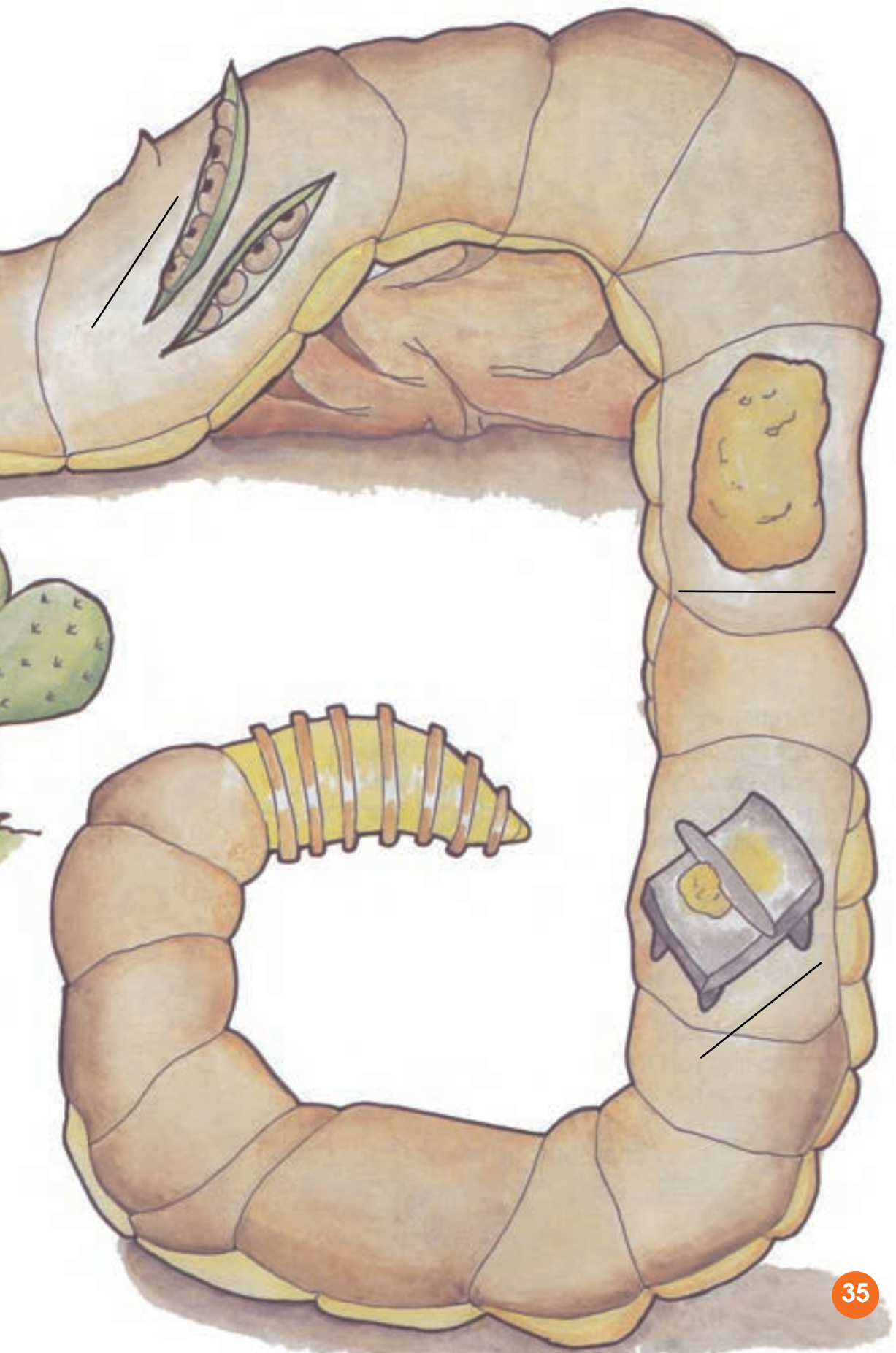



NONANA

Tlasojtli iuan namikilia nonantsi; nimitsneki ika nochi
noyolo ijkuak techajua chikauak
nechkokoua iuan nimitsyolkaki; kuali
nechyolitia, iuan nikaki motlajtol pampa nechpaktia
miek.

Nimitsnekis semijkak; nimitstlasojtla nonamik
amonikauas titlajyouis notlajtlakol, achto
nimikis.

Te tlen noyolo monakayo; te otiktemakak moyoliskayotl
iuan amo otimoyejyeko timilkis
iuan okachi otikneki ninesis.

Amador Contreras Carranza

**Xikita tlen onka itech ni flatsakuali iuan
ximotlapoui iuan oksekime koneme
koxokiuelitake noso amo.**



Xikita tlen onka itech flatsakualme,
ikinpoua iuan xikijkuilo ipan koujtsitsinti.



se _____



ome _____



eyi _____

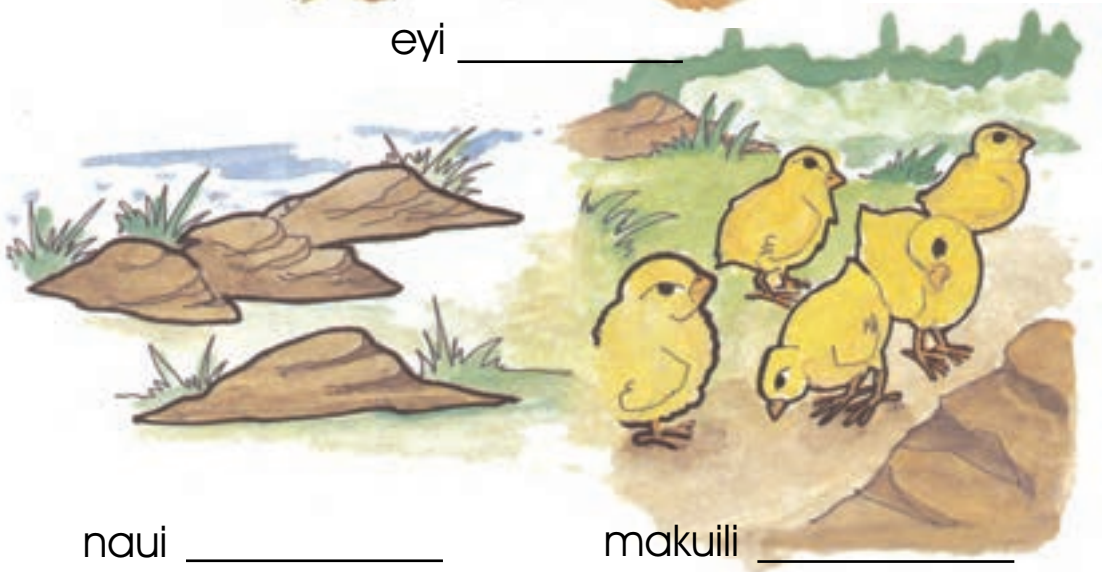

naii _____

makuili _____

Tlen ijkuilitok ipan ikuitlapil papalotl
xikinpanolti itech in mixtli ipan
koujtsitsinti.

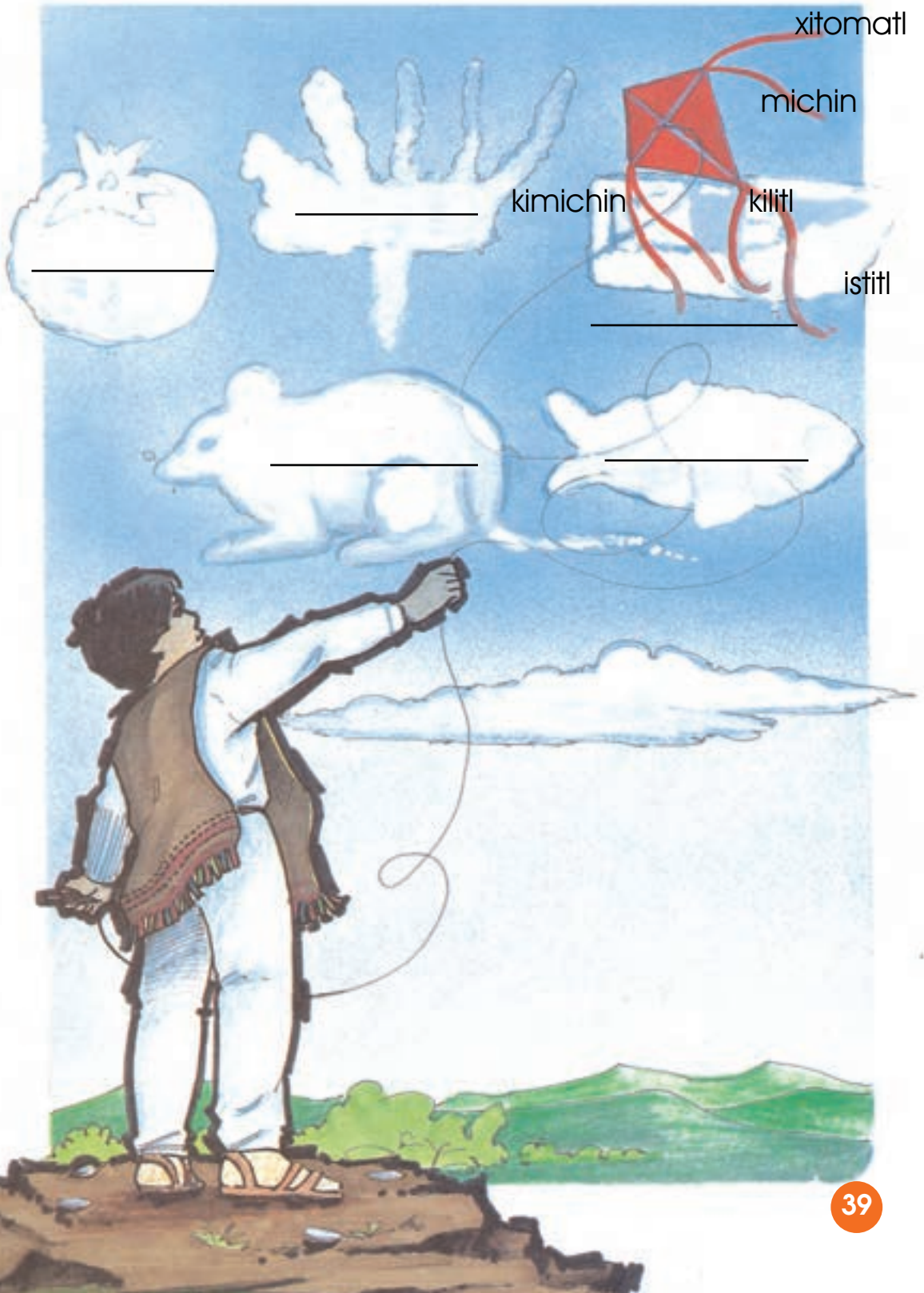

Xikpouaka te iuan oksekime koneme ni
poualistli tlen kajki itech



Tlatsakualme iuan xikijto: otikuelitak noso amo.

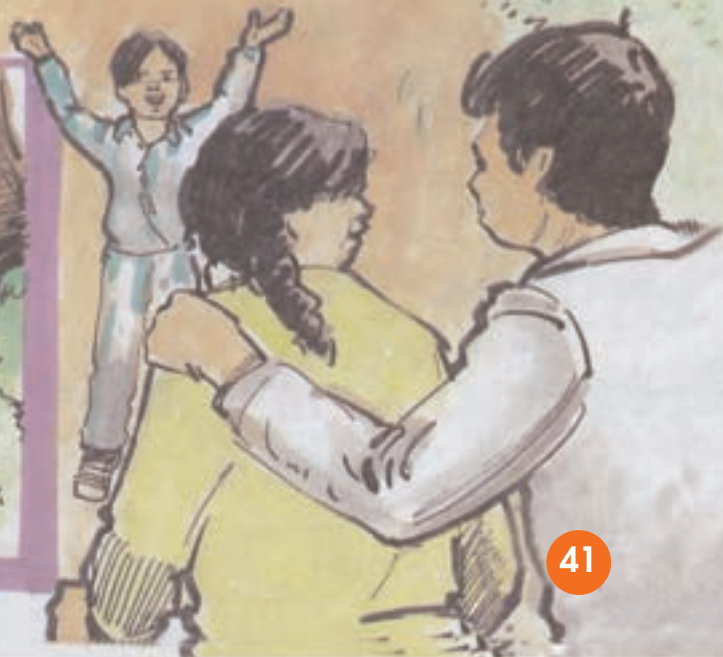

Tlajtolenepantlamilis



Notata koujima miek
pampa ye
tlapechnemaka
tejua tikpaleuia miek
pampa ye nochi techmaka.

Nochti tejua timotlasojtla
nochtli tejua timoyekuika
iuan ijkuak tiaui koujtla
tinochti peua titlakuika.



Nonana kichiua tlakuali iuan
tinochti tikuelilia pampa
ye kichiua kuali iuan ye
techtekilia.

Okinchi: Xilonen



**Te iuan oksekime koneme xikijtoka itech
katliye tanajtli yaui flajtolme tlen kate
itech flaxkali.**



TLAJPALOLISTLI



Panoltijtsino
nanantsi



Panoltijtsino
temachtijketl



¿ken oton motlan exiltli?

Kuali, kuali
¿iuan tejuatsi?



nui, ki ton mota
okekentsi

kuali kajki
tonmota



Itech ni atexajkatl kate sekime
flaixnextilme te xikimita kuali iuan itech
tlatsakualme xikintlalili intoka.





NOTATAUA

Ne notoka Xilonen, notata itoka Xokoyotsin iuan nonana itoka Sittlalin.

Ne nikipia orne nokniua iuan ne nikipia chikueyi xiuitl.

Noaltepe itoka Masatiankisko iuan kajki itech tlatlajko tepeme.

Ompa kanin nichanti, kate mieke yolkame, kenomi: piome, pitsome, ueuejchome, itskuinti iuan se miston.

Ne nikintlasojkamatilia miek notataua pampa nechpaleuia miek pampa uelis nimomachtis.

Xilonen

**Xikpoua nochi tlen nika tlajkuilitok iuan
ximotiapoui iuan oksekime koneme
kenomi onkita nochi.**



Nonana itoka Sittalin



itoka Xokoyotsin.



Ne notoka Xilonen.



Masatianskisko.



Tikinpia mieke yolkame.



Tiktoka xitomatl.

Itech pitsokoneme kate sekime
flajtolme; xikimita flaixnextilme iuan
xikita katlie pitsokonetl kivalika intoka
iuan xikimijkuilili ipan koujtsitsinti.



omitl

okuilin

kolotl

olotl

ostli

Iuan oksekime koneme ximaulti;
xikchiuaka omoixko kenomi kichijtoke
xochitsitsinti.



Xikintlalili tlajtolme ye kakistli tlen poliui.



k _____ eitl



ij _____ itl



te _____ ksistli



tek _____ ani



itsk _____ intli

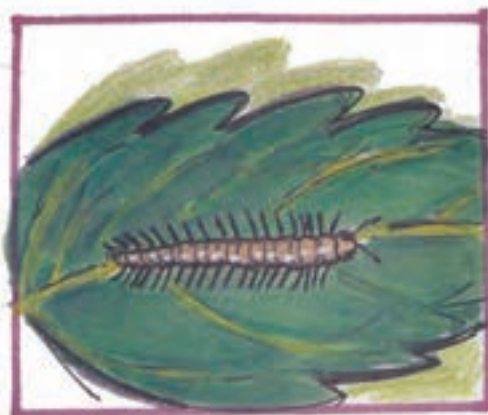

ok _____ ilin

Xikinpanolti sekime yolkame ijtik
flatsakualme ompa tlalchi kate intoka.



kaxtili

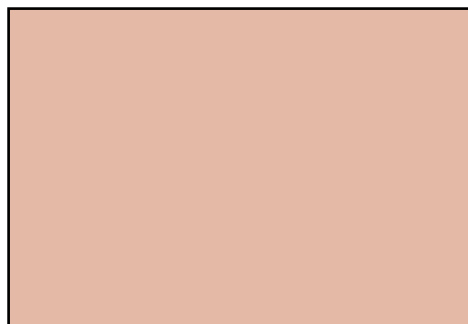

tototl



ueuejcho

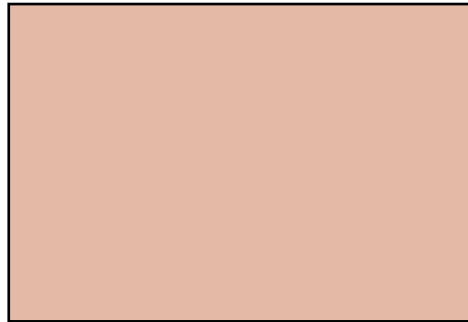

piotsi

Xikintlalili intoka ipan koujtsitsinti iuan
xikimixnexti kanin kajki intoka.

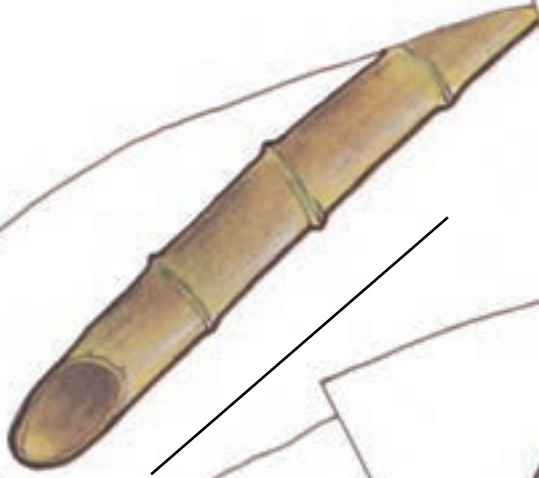

mili



miston



kueitl

kolotl



auakatl

epatl





TEUKSISTSINTLI TLEN OKAJSIK YE TOMAKSI

Ye okasik se teuksistli
ye okitlali ijtik se kaxiti
ye okistau
ye okinelo, okinelo uan
okinelo
ni tomaktsi okikua
ye tototsi omoka iselti
pampa ni tomaktsi
okikuali iteuksitsi.

Nochi tlen nika timitstlalilia xiknechiko,
xikinsetili iuan xikintlalili intoka.



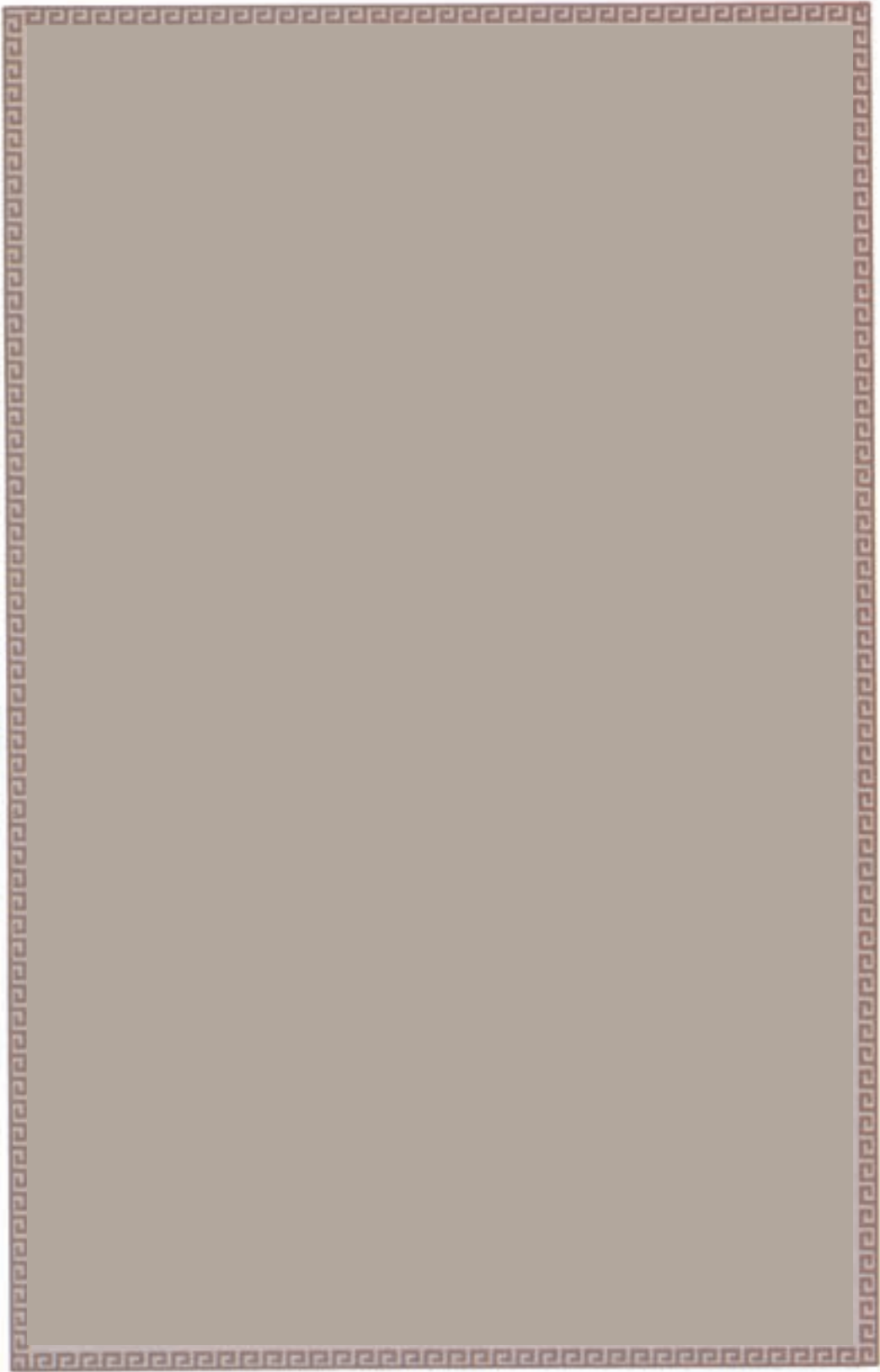

OJPA AMATLAXELOLI



Ixtlauak Altepeko

Kenomi motekiuika nohti tlakame.



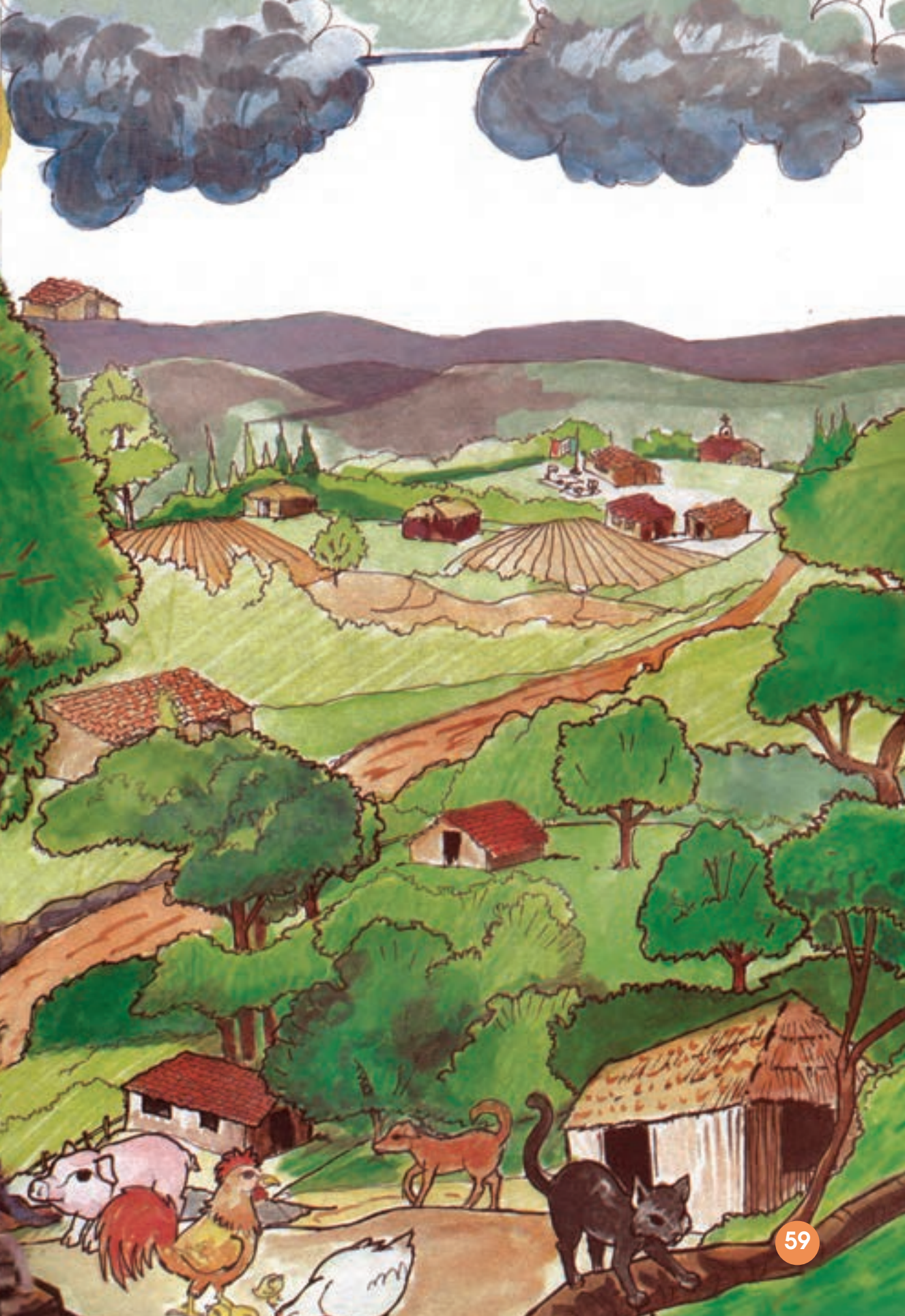



NOALTEPE

Noaltepe itoka Santa María uejkapa; amo mokaua uejka ompa ueyi altepetl teuajka. Tlakame, siame iuan chokome kitoka ye etl iuan tlayoli.

Onka miek mexkalokuili ijkuak kiaui. Ompa noaltepe tlauel tlayoua; amo onka mekatlauili.

Ofelia Maceda

**Te iuan oksekime koneme ximotlapouika
flanin onkita nika iuan xikijtoka flanin
onka ompa omoaltepe iuan kenomi
kate nohti kalme.**



Nika kate yejua
tekiuajke.



Ni ye kaltlamachtlistli.



Ijkuak timokokoua nika
techpajtia.



Tinohti titlakoua
nika.



Nika tlapakatiui nohti
siuame.



Nohti kaltsitsinti
kate ueuejka.

**Xikita tlen kichua tlen kate ijtik flatsakualme
iuan xikijkuilo ipan koujtsitsinti.**













TLAPOUALISTLI



¿Tlempa tipaki takotsi?



Ne nipaki pampa yiuelis mimomachtis



Te tikijta timomachtis yikipia miek xiuiti kajki kaltlamachtilis.



Yineli uan ompa momachtia yejua koneme tlen yiuejuei



Iuan te ¿kanin timomachtis?



Ne nimomachtis kanin momachtia koneme tlen yikin kipia nau iuan makuili xiuitl.



Iuan te ¿keski xiuitl tikpia?



Ne nikpia makuili xiuitl.



TOTEKIUA

Ye totekiua tlen tlanauatia nika, otechnechiko iuan otechtlajpalo itech ni tomaseual altepetl iuan otechiljui techpaleuis tikueitiliske ojtli pampa uelitis tiualejkoske ompa kanin kate ueyi altepeme iuan uelis tiknemakaskes okachi kuali nochi tlen tejua tiktoka iuan tiktekipanoua.

Nika xikita kenomin omopatlauijtia ni
altepetl, iuan ximotlapoui iuan oksekime
koneme kenomin mopatla omoaltepe.







KUALTSI ALTEPETL

Nika itech ni altepetl semijkak kiaui iuan ualeua maski tona kiaui iuan motlalia kosamalotl.

Sailiuis koujyo uan nuijki onka akatl.

Kate mieke yokame kenomin: kalame, kolome kilime, kimichime iuan oksekime yokame.

Nika akin ejko tikselia ika miek pakilistli.

Tlalchi ijtik etsitsinti kate sekime
 flaixnextilme, xikinpanolti ijtik
 flatsakualme kanin kate intoka.

kali	kimichi	kolotl
kiavitl	kosamalotl	okuili
kili	kouatl	kouitl

kosamalotl	kouatl	kiavitl
kouitl	kolotl	kili
kimichin	okuilin	kali





KAXTILTSI (Tlakuikali)

Se kaxtiltsi
tlakuika iuan tlakuika
tlakuika iuan tlakuika
chikauak se kaxtiltsi
pampa tlakuika sepa kualka
sepa kualka nohti meua
pampa ye kaxtiltsi kimiljuia
ximeuaka, ximeuaka
kimiljuia ijki:
kikiliki, kikiliki.

Xilonen

**Te iuan oksekime koneme xikijkuiloka
ipan koujtsitsinti nochi tlen onkita ijtik
flatsakuali.**





PALEUILISTLI

Amo onikmatia tlen itoka
axka kema ijkuilitok
paleuilstli itoka ye tlajtoli
tlen tinochti timaseualtlakame tikchiua
nika ipan ni ueyi tlaltikpaktli.

Xilonen

**Te iuan oksekime koneme xikitaka tlen
onka ijtik ni tlatsakuali iuan
ximotlapouika koxonkiuelitake noso
amo.**



Nochi omejua xikintlalilika intoka ijtik
flatsakualme, nochi flaixnextilme tlen
nika kate.

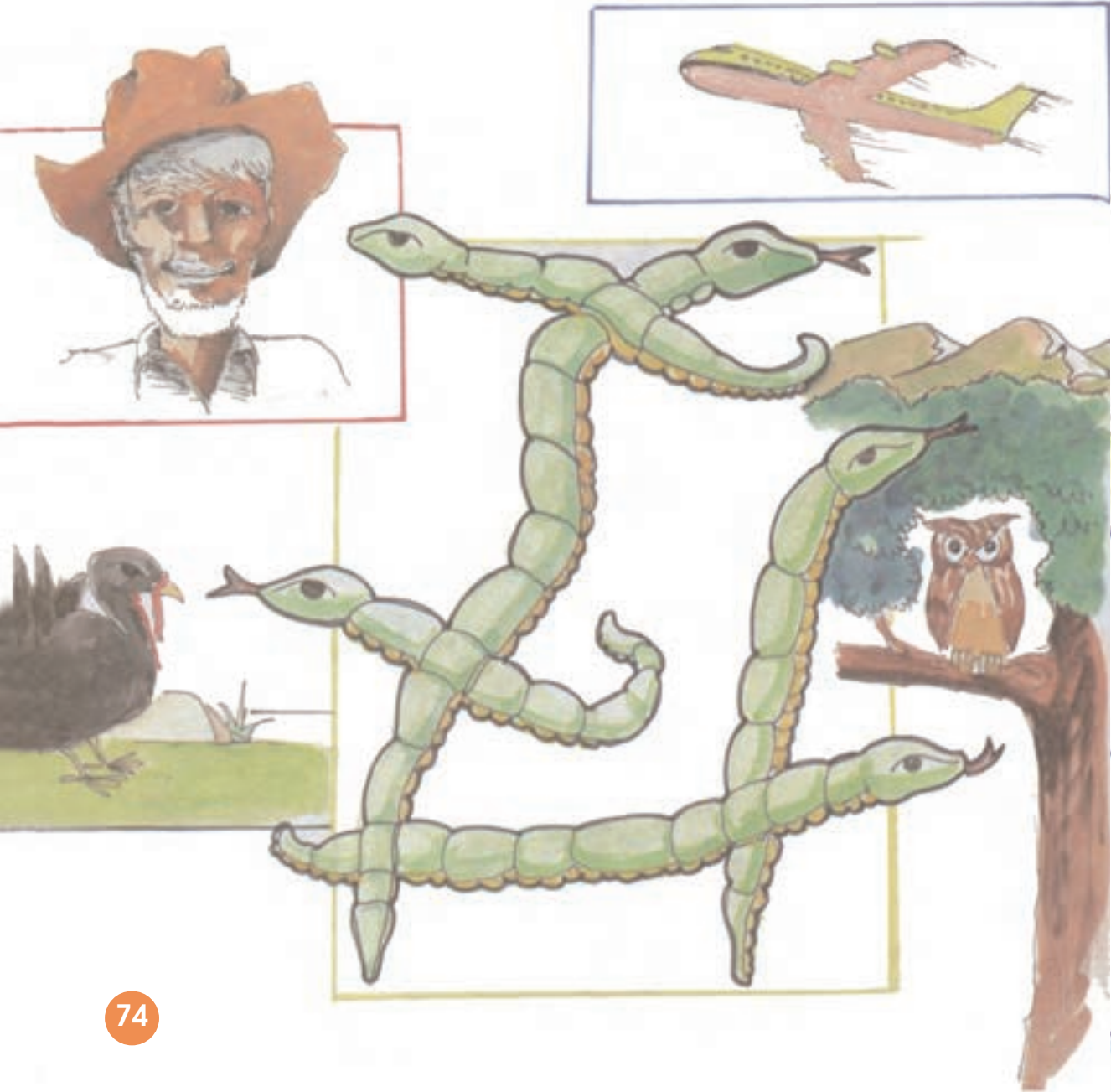

**Te iuan oksekime koneme xikpouaka
nochi tlen ijkuilitok iuan xikaxitilika
tlajtolme tlen poliui.**

Se _____ patlani maski etik,
ijkuak se maseualtlakatli ixpoliui _____
tlakuika.

Nonantsin okichi se _____ ika moi,
itech _____ kate mieke yolkame
kojkouiti uejka.

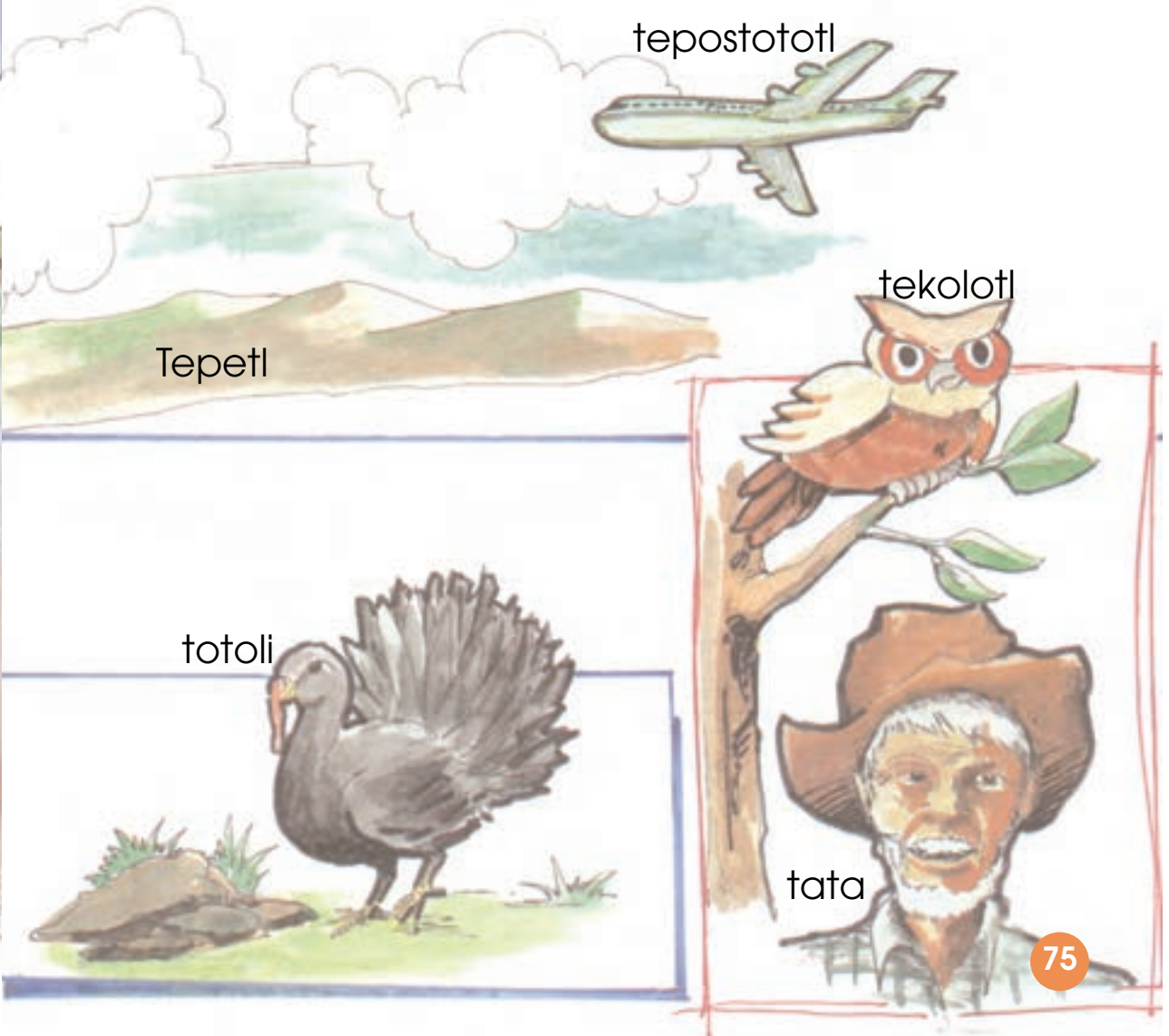

Ijtik ichkatsitsinti kate sekime flajtolme; te xikintekpana itech koujtsitsinti; tlen kate moyekma yejua yolkame iuan tlen kate mopochma yejua oksekime flajtolme.

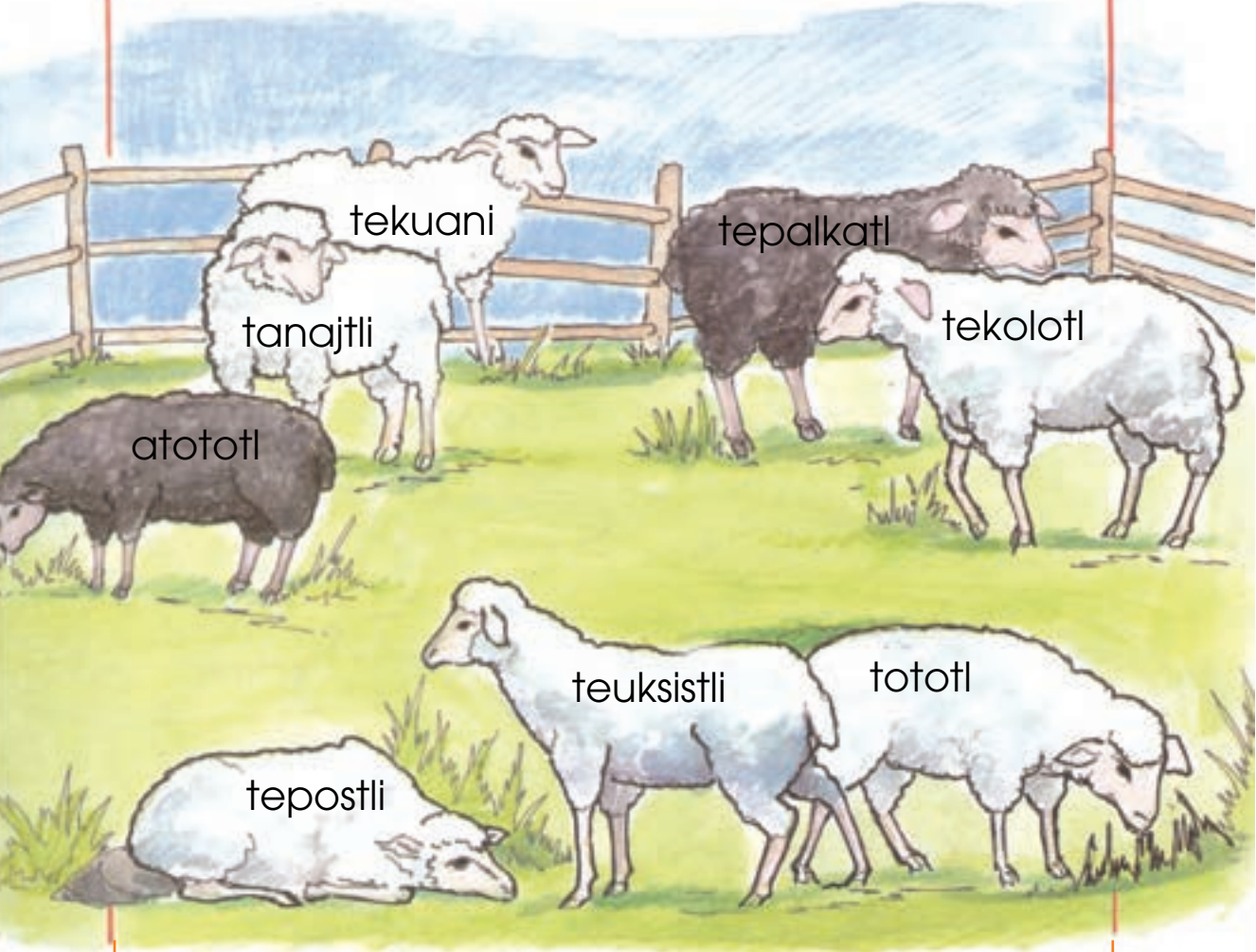

**Nika timitstlalilia sekime flajtlanilome
uan te tikijtos tieno.**

Tikinpia itech tomaua
uan nuijki itech tokxiua
majtlaktli itech tomaua
uan nuijki itech
tokxiua.

¿tlen intoka?

(mɔjɔlɔw)

Kinpia eyi ikxiua
uan ye ixpatlauak
mopaleuia ika se ima
pampa uelis timotixilis.

¿tlani?

(metlɔtɔ)

Mitsmaka motilma
uan amo tlakame
yejua mitskentia
ijkuak tisekmiki.

¿akinme?

(ichkanɛ)





TOKOJKOLJUA

Intlajtol yejua tokojkoljua kipia miek
ixtlamachilis sejse itlajtol tlen kiteneua yejua
miek ipati yejua techyekana, yejua
techyekuika.

Xilonen



Tinohti tlen tikpia tositsin tikpia se ueyi tlayekanki;
matimotlasojkamatika.



Se ueyi iuan kuali tlajtoli kitemaka se ueyi tlakati
tlen tiktokayotia kojkoltsin.

Xikinpanolti nohti michintsitsinti tlen
kate ijtik atl itech matlame
kate kakisme.

K

M

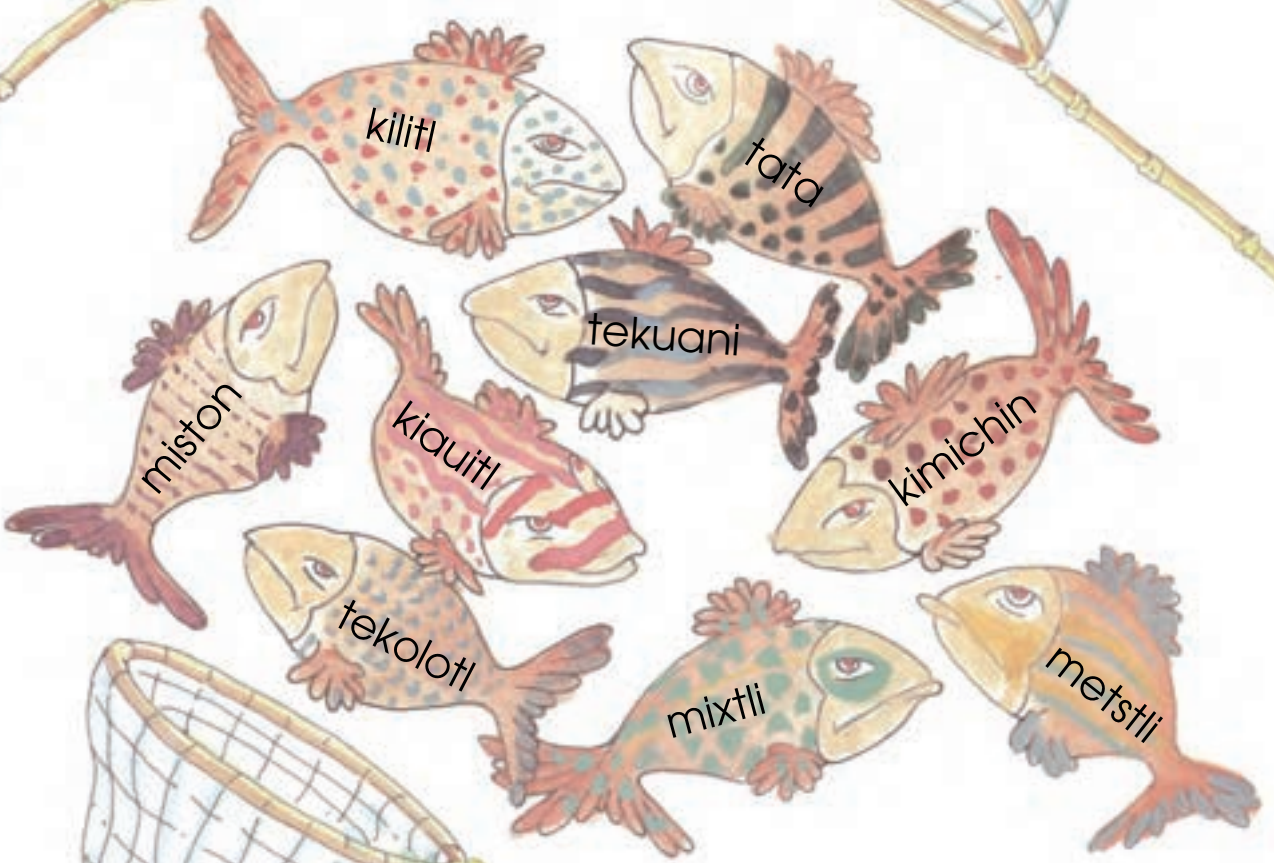

T

Xikintlali intoka yolkame ipan koujtsitsinti.



Nochti tlajtolme tlen kate ijtik ueyi
xoktsintsi xikinpanoltika ijtik xoktsitsinti.



Kali
tokali
michi kouatl
tixtli masatl
kueitl
tototl



MAKUILTAKATL ALTEPETL

Momati ijkuak yikinika omotlali ni altepetl, sanyejua makuili tlakame ompa ochantito. Satepa omoueitilijtia pampa yejua okintemojke insiua iuan sanima ikoneua axka yichanti mieke iuan kate ika miek pakilistli.

Xikintlalili intoka ijtik tlatsakualme.



Iuan oksekime koneme xikimitaka kuali
flatsakualme iuan xikijtoka kanin kate
sejse iuan kani okachi.



taktli



takme



kaktli



kakme



michin



michime

Kanin poliui itoka xiktlalili iuan kanin poliui tlaixnextilis xikchiua.



ouatl

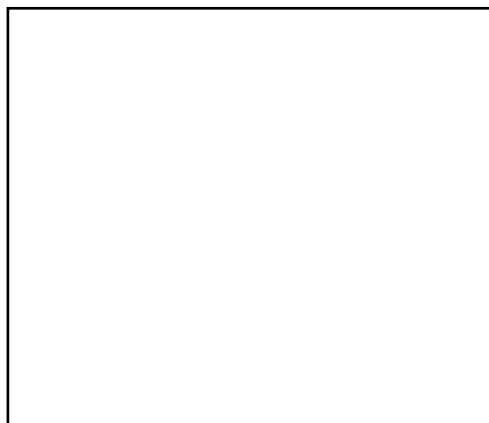

kouame

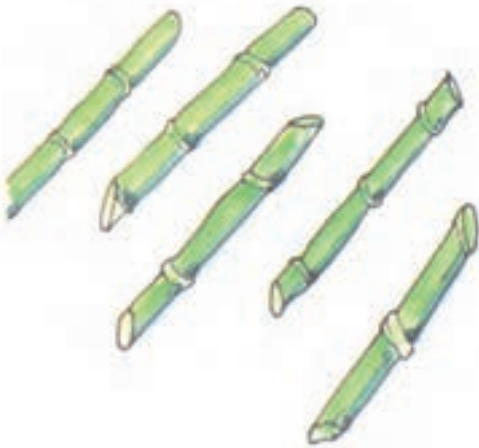
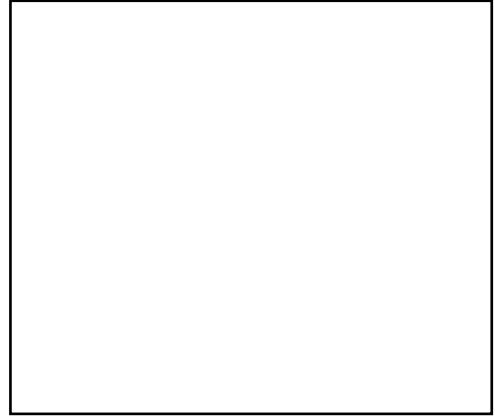

kali





nolti nolti
timota eje

TLAJPALOLISTLI



- nolti - nolti
- kanin tiau - nitlakouati
- kani - ichan tata xokoyotsin
- timota - timota



- panoltijtsino - panolti nokone
notajtsin - kenomi
panoltijtsino otimotlanexilti
nonatsin - nuijki kuali
- kuali, kuali - axka totoka
iuan omejuantsitsi ximixami iuan
- kualica titlakuas yitias
 timomachtiti



- panoltijtsino - panolti nokonetsi
notatatsin - panolti nokonetsi
- panoltijtsino - kuali nokonetsi
nonanantsin uan te
¿kenomi - kuali kajki totajsi
onmotlanexiltijke? mitsuika
-ne nuijki kuali,
tonmota



-nolti
-nimomachtiti
uan te timota

- kani tiau choco
- ne nitekipanoti
timota



- panoltijsino
-kanin toyajtiu
-ne nokalijtik
kualika tonmota

- nolti
- nimotixiliti uan te
timota chokotsi



- panoltijsino tata
tonmota tata

- panolti chokotsi
kuali kajki
chokotsi timota



- panoltijsino nan
- tonmota tata
tlasojkamati miek

- panolti chokotsi
- kuali kajki
chokotsi totejtso
mitsuika

**Te iuan oksekime koneme ximauiltika,
motemachti omechpaleuis.**

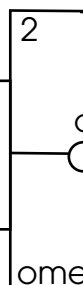
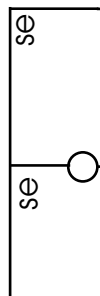
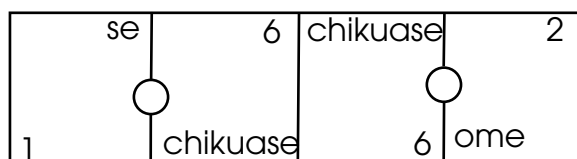

METSTLI

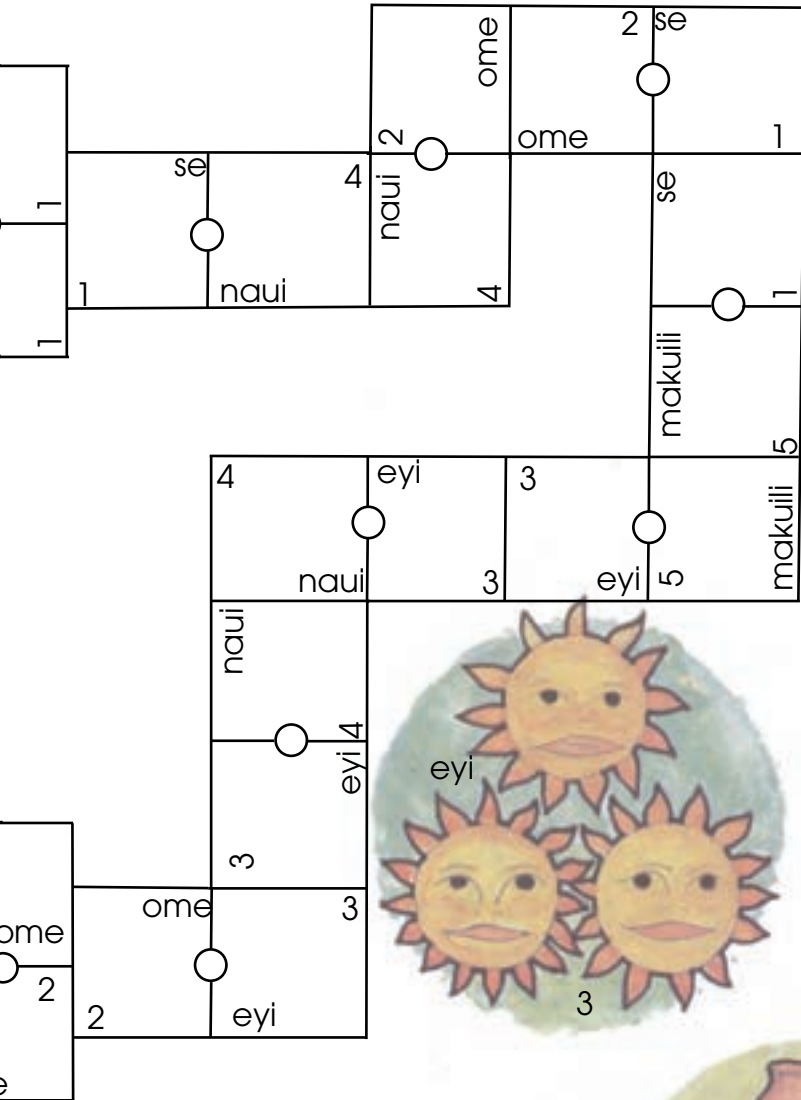

**Ximaultika nohti omejua; xikchiuaka
kenomin kichiu nime yolkatsitsinti.**



EIXPA AMATLAXELOLI

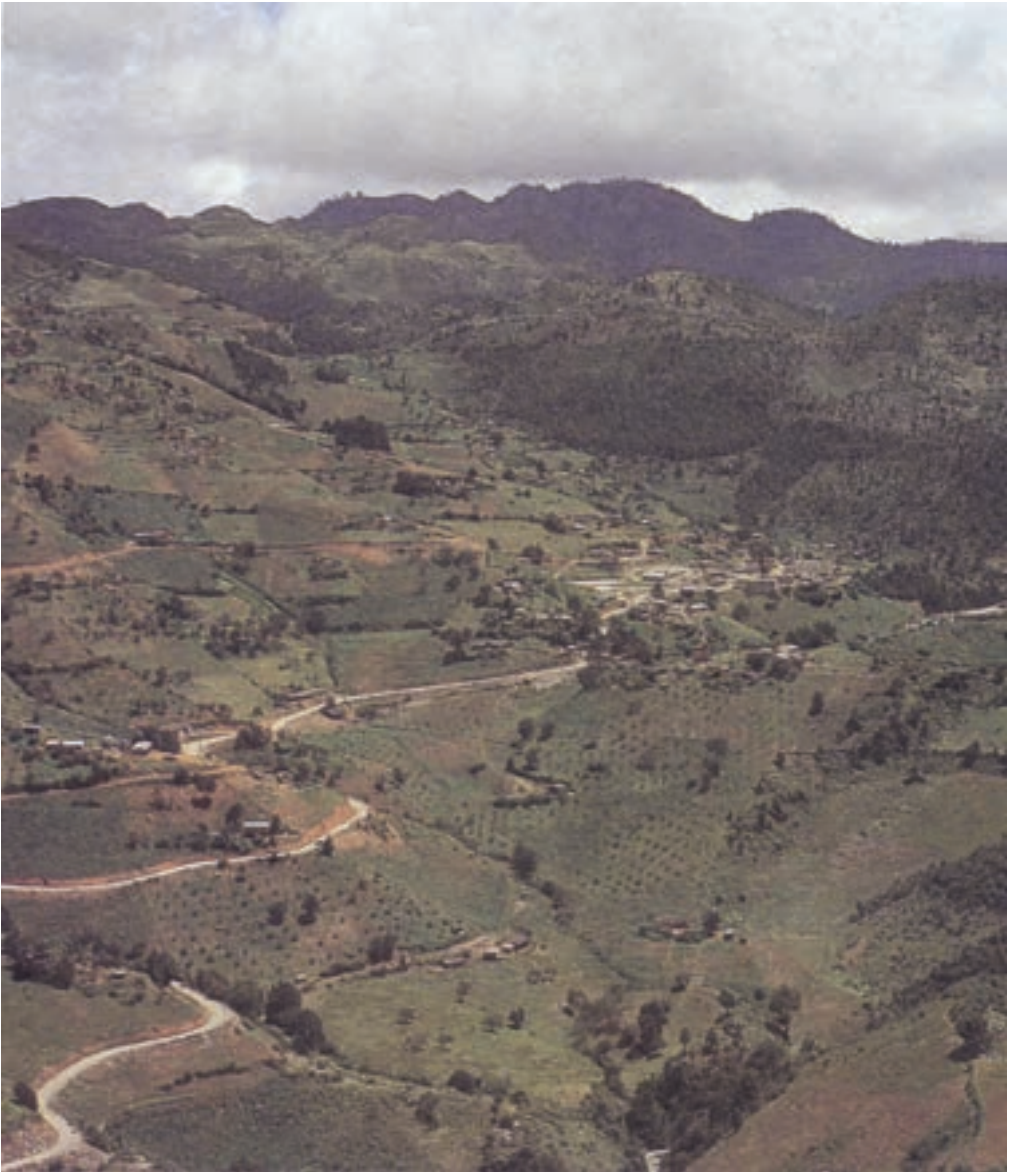

Nochi tlen techyoualoua.







Kimichime amo kuali
makalakika kalijtik
pampa timokokoske.



Apiome okachi kiuelita
yetoske ijtik atl ken
itech tlali.



Ni kaxtiltzi tlakuika
kualka; ye kimeuالتيا
itekoua.



Tekolotl kisa youak
iuan kimotemachiltia
ijkuak aka mikis.



Tochintsi omotlati, ijko
amo uelitis kimiktis ye
tlatemouani.



Tekuani motekipachoua
pampa amo ouelik
okinkua sekime piome.



Ni okuilintsi kipia
kualtsi itlapalo..



Ni kouatl kineki kitsopitis
se tlakatl.

Xikita tlani onka ijtik flatsakuali iuan
xikijkuilo ipan koujtsitsinti nochi tlen te
otikitak.

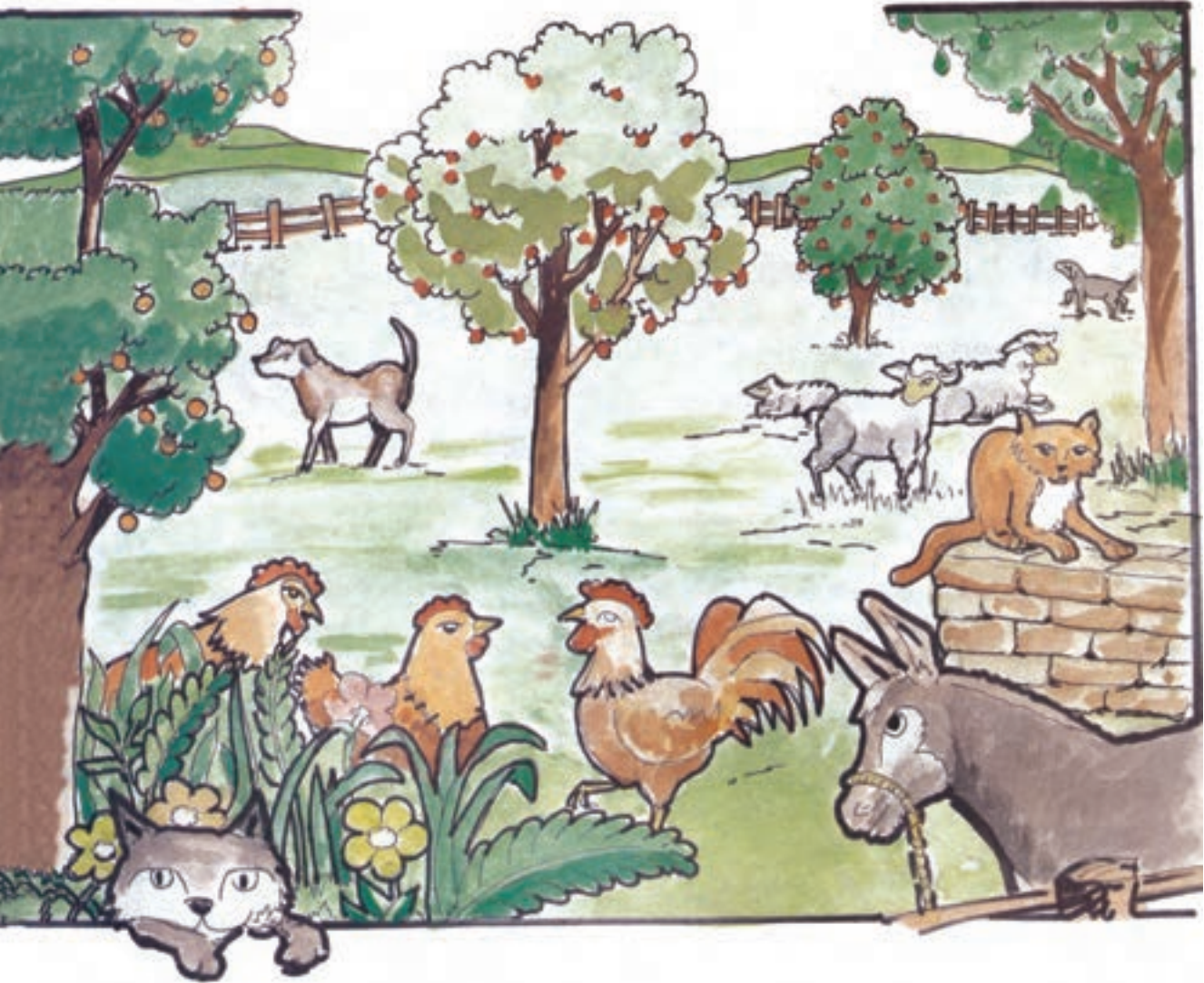

**Te iuan oksekime koneme flani
onkiuelitake tlen kajki ijtik flatsakuali
iuan xikpoua tlen ijkuilitok tlalchi.**



TLEN TECHYOUALOUA

Nika kani sailiuis koujyo kate mieke yolkame,
tlen mixeuia te amo tikimixmati. Kate kouame,
totome, masame, tepeitskuinti iuan oksekime,
yolkame; nuijki onka miek tlakilotl kenomi: koyoli,
tsapotl, tepexilotl, xokotl, xalxokotl, kajue,
koujtsapotl iuan miek okachi tlamantli,

Itech ni nojpali kate sekime flaixnextilme
te xikimita kuali iuan itech tlatsakualme
xikintlalili intoka.

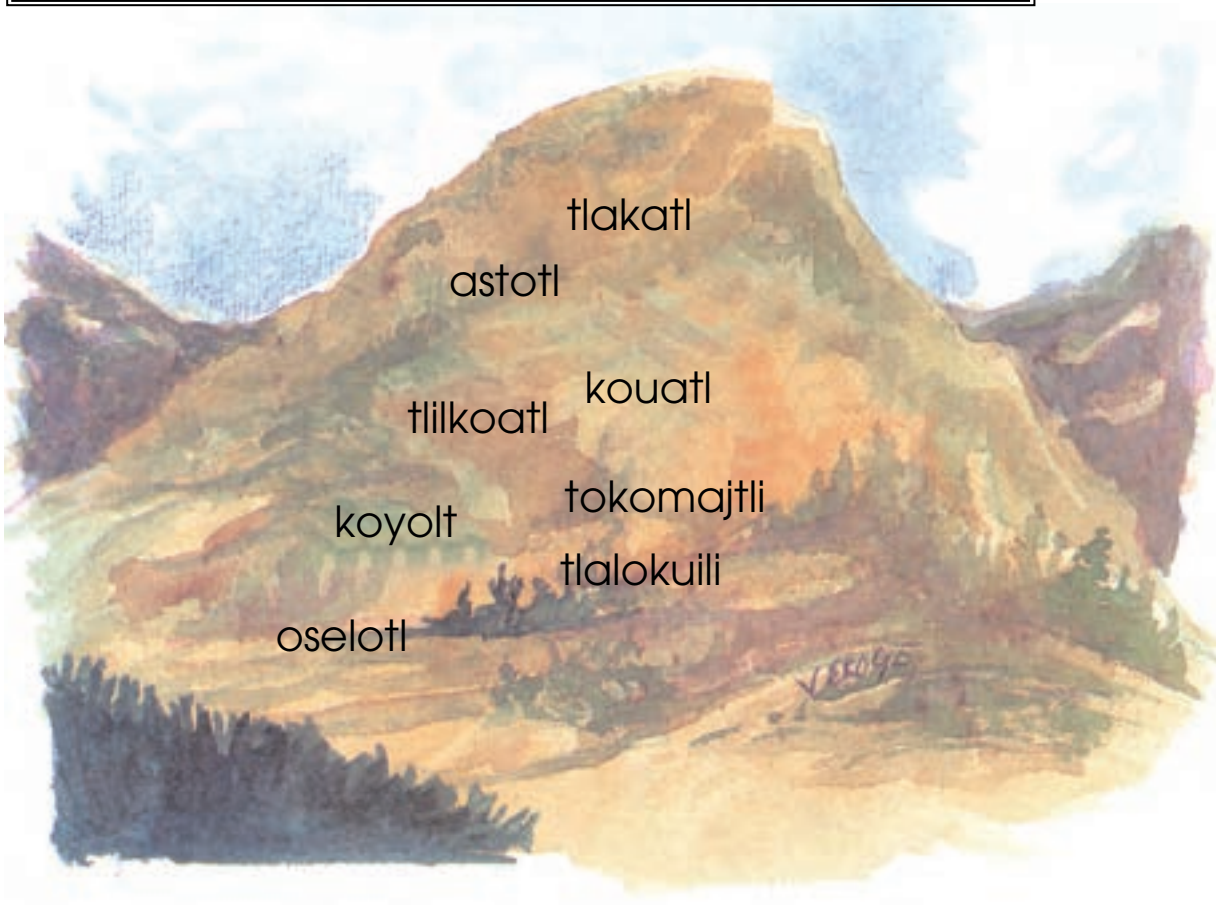

Ijtik chikiuitl kate sekime tlakilome tlen
okachi tikinuelilia xikintlali intoka ipan
koujtsitsinti.





SE TONALXOCHITSIN

Momati ni xochitsintli pampa sailiuis kuajkualtsi okatka, omokopki machitl iuan ijko ye xochiteko okiljui: te sailiuis timachitl, pampa kualtsi timota ijkuak tixotla, axka ne nimitskauas xixotla se tonali: kualkantsi tixotias tlajka tixotlatos iuan ijkuak tiotlakiltias te timotsakuas iuan sanima tiuakis. Iuan axka ijko kipanoua ni xochitsintli sanse tonali xotlatok.

Xilonen.

Te iuan oksekime koneme ximotlapouika
katliejme yolkame onkimixmati iuan
katliejme amo.





PAPALOTL

Se tonali se papalotl opatlaniaya kanin sailiuis pilsakayo iuan totoka okitak se okuili iuan opejki kiuetaskilia iuan kipijpinatia, iuan okijto: te okuilin sepa titemojmoujti ijkuak timitsita, ne techita nikuajkualtsi nikpia miek notlapalo iuan okuili okinankili: te amo tikmati nikachto otikatka tiokuili kenomi ne iuan satempa otimopatlak, Tleka axka amo tikneki tikilnamikis. Ni tlajtoli kijtosneki: amo semi tikteneuaske itia tlamoyineli, yejo amo kuali.

Xilonen

Ika koujtsitsinti xikinsetili flakilome uan
yolkame; te xikijto flani kikua yolkame.

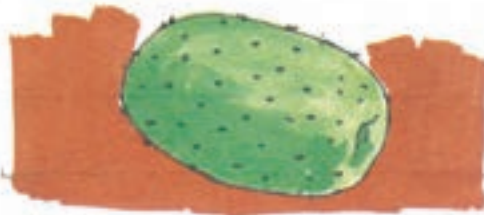

**Xikita tlani onka ijtik flatsakuali iuan te
xikchiua se flajtolpoualistli ipan
koujtsitsinti.**





KOUJTLATEKILIS

Tokojkoljua techtlapouia nikijkuak tiknekiske tiaske tiktekitiui se kouitl moneki tikchiaske mamotlali metsi kuali tentok, mamochikaua, pampa ijko ni kouitl uejkauas iuan amo sanima palanis noso kuakualos.

Sekime tlakame amo kineltoka iuan yauí kitekitiui kouitl iuan amo kita metsi koxyochnikauak noso amo iuan sanima peua palani nochi kouitl tlen okiteke.

**Xikintlalili intoka iuan achto xikita tlani
onka ijtik sejse flatsakuali.**



**Xikita tlen opanok nika iuan xikijto
kenomi uelitis moyektlalis.**





KOUJTLA

Yejua koujme techmaka toyoliskayotl
Yejua techejekauia;
tlatejua tikneki tiktekiske se,
achto moneki tikintokaske orne,
ijko amo semi poliuiske
iuan amo semi tlamiske.

Xilonen

Ijtik atl kate sekime aplome iuan kipia
flajtolme; xikinpanolti kanin kate
uakalme.

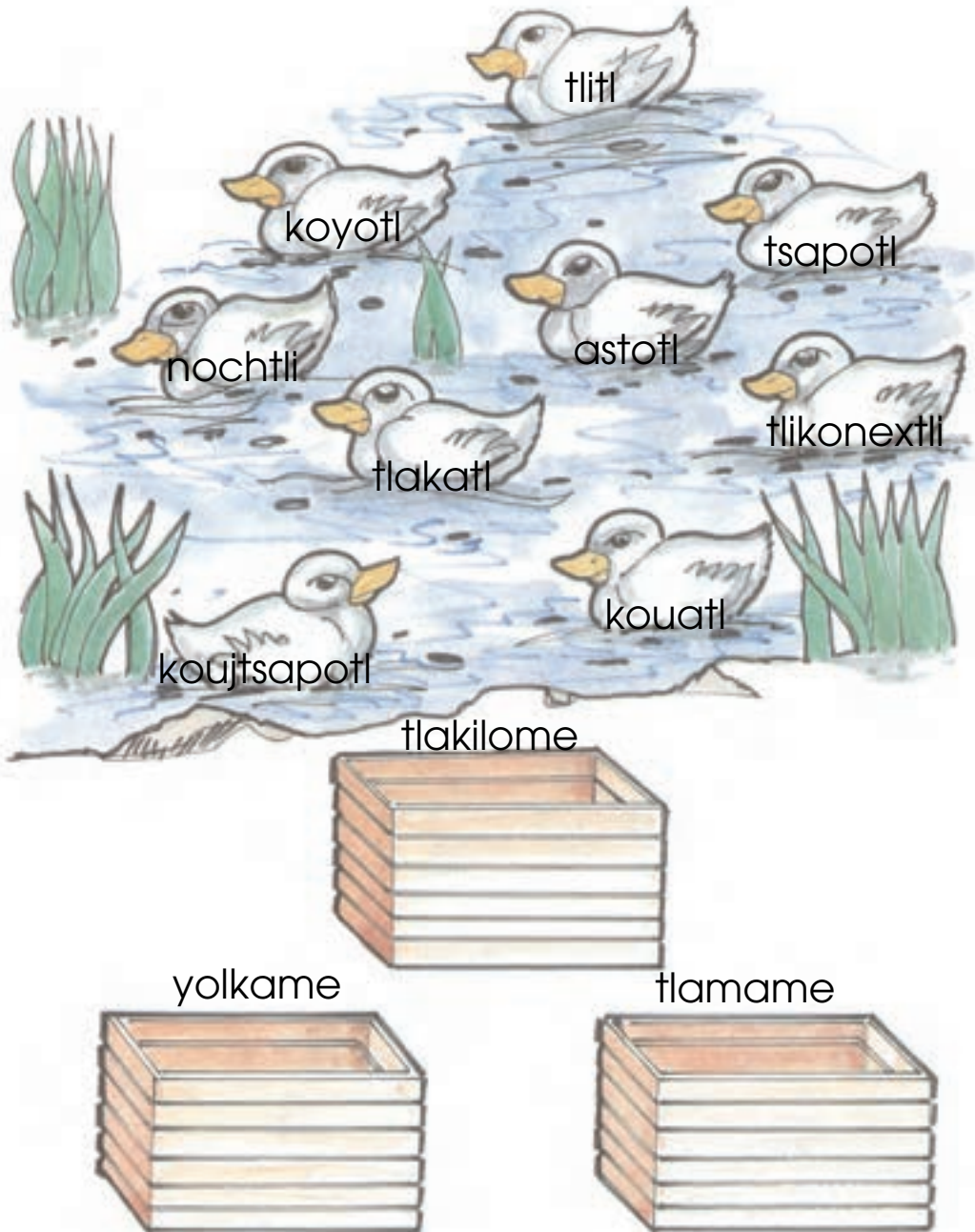

Ijkuak omejua omechuikas omotemacht
onejnemitiui ompa omoaltpe, Kanin Koujyo
iuan kani nesi atl ʔtlani moneki
onkichiugaske?



Moaltepetl kanin koujyo iuan kani nesi
atl ȳtlani tikyejyekoua tikchiuas.

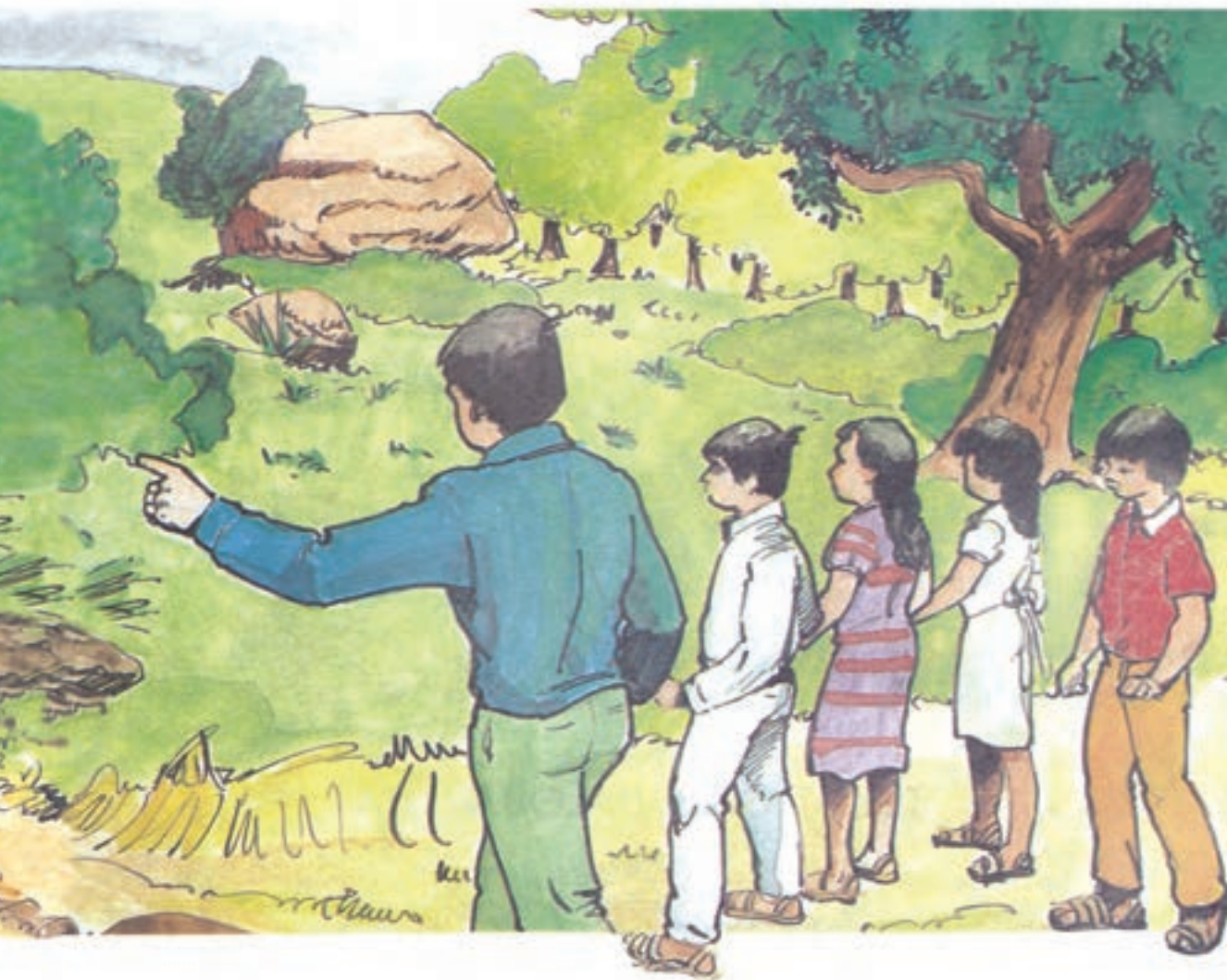



TLEN TECHYOUALOUA

Nochi tlen techyoualoua,
moneki tikyolitaske
pampa tonantsin ye totlaipa,
pampa totajtsi ye tonaltsin,
pampa yolkame techtlamaka iuan techpaleuia,
pampa atl iuan koujme ye toyoiskayotl,
pampa xiujme ye totlakual iuan topajui.

Xilonen

**Xikinsetili ika pitsmekame ye flapalome
iuan flakilome; amo xikinepano
pitsmekame.**

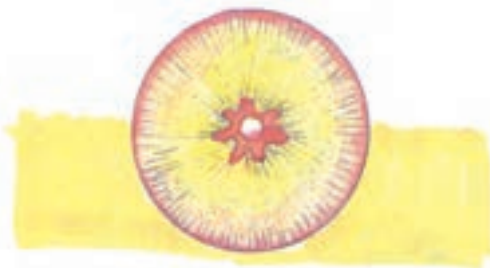
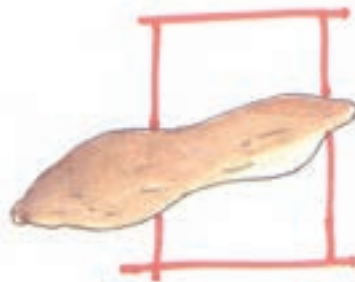

Xikita kuali nochi tlen onka ijtik
tlatsakualme iuan xikyektlali se
tlajtoltlapoualistli ipan koujtsitsinti.





TONANTSI TLEN OTLAPALEUIYA IJKUAK OTOKAYA IUAN OTLAOLOLOUIAYA

Kijtoua, yiuejkika okatka se tonantsi iuan ye okitaya iuan okiteochiuiaya ijkuak otlatokaya iuan ijkuak otlaololouiaya itech nochi tlali. Iuan ni tonantsi ijkuak okitlasojkamatiaya okimakaya nochi tlen okachi kuali otlakia.

Satapa sekime tlakame opejke kichiua okse tlamantli iuan amo okokilnamikia ni tonantsi, iuan ye okualanki iuan amo okokinpaleuiaya; ni tonantsi okiljui ye totajtsin tlen kinauatia atl, amo makinmaka atl ijkuak kitoka itla.iuan ijko nochi tiali otlaueluaki iuan ijko amo akitla otlakia iuan nochi opejki mokokoua iuan ijkuak okimomachiltijke nikye tonantsi omokualanijtijtoka yejua inamak intonantsi omotlapojpoljuijke iuan ye omoyolali iuan oksejpa okinpaleui.

Hortensia Hdez.

Xikpoua se flajtolpoualistli tlani onkichiua
flajka iuan tlani ijkuak yotlayouak.





Itech nime flatsakualme Xikita tiani
kichiua se Chokotsi ipan se tonali. Axka
te xikijto tani tikchiua nuijki.

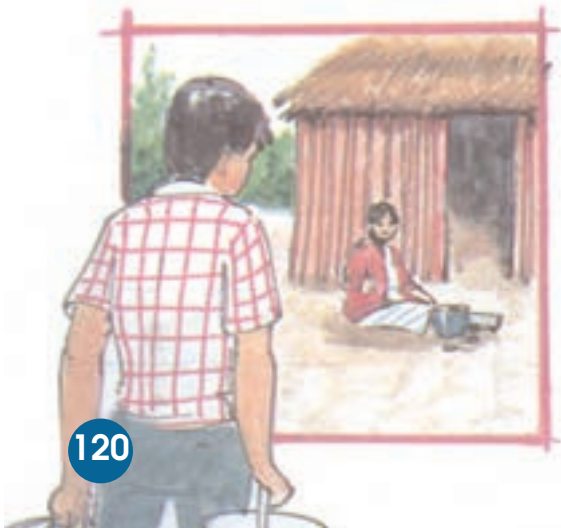



tlakuika, tlakuika
iuan amo tlakatl
mitseualtia kualka
iuan amo tonaltamachi

¿tlani?



(kaxtli)

se tlakatsintli
nochi tonali kualka kisa
ualeua amo tikita
pampa mixtli kitsakuilia

¿akini?



(tonali)

**Nika ipan koujtsitsinti tiktlalis tlani
tikchiua sejse tonali; itech chikome
tonali.**

Achtopa tonali _____

ojpa tonali _____

ojpa tonali _____

naujpa tonali _____

makuilpa tonali _____

chikuasempa tonali _____

chikompa tonali _____



Se kimichi kineki kikuas se
tsopeltlaxkali, iuan miston amo
kineki kikuas tsopeltlaxkali,
kineki kikuas ye kimichi

Xalxokotl tlaki tlatsintla
amo nochi xalxokotl tlaki
ompa, nuijki tlaki itech
oksekime altepeme.



Nochti yolkame tlakua,
amo nochti yolkame kipia
nau i maua.

**Nika xikita flani kichiua, iuan xikijto flani
amo kuali se kichiuas.**



Ni chokotsi kitlamotla
tlajsoli.



Ni chokotsi keualtia tlajsoli.



Ni tlakatl koujteki.



Ni tlakatl kitoka se kouitl.



Ni choko ijkuak tlatlasi
amo motentsakua.



Ni choko motentsakua
ijkuak tlatlasi.



AMO XITLAKOUJTEKI

Amo xikinteki koujme
pampa yejo amo kuali;
amo kuali tikintlamis,
pampa titlamis ika toyoliskayotl
¿amo tikneki tiyolitos?
¿amo tikneki tiyektietos?
te tikmati tlani tikneki
te tikmati kentitlamis.

Xilonen

Xikijkuilo ipan koujtsitsinti tlani tikita ijtik
tlatsakualme.





Xikita kuali nochi tlen kajki ijtik ni flatsakuali



ivan xikchiua se flajtolflapoualistli.



**Nika timitsintlalilia sekime flaixnextilme
ijtik flatsakualme; te xikinyektekana
uan xikijkuilo se flajtoltlapoualistli.**



Nika xikinyektekpana iuan xikijkuilo se flajtolflapoualistli.

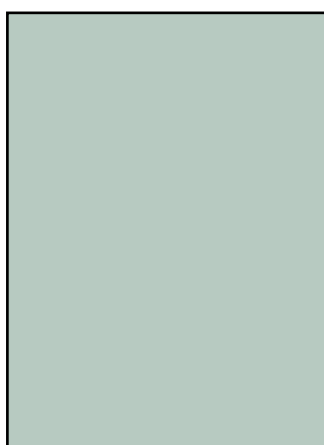
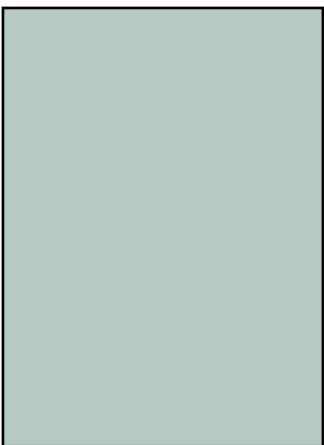
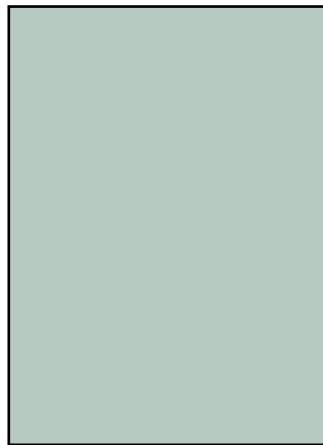
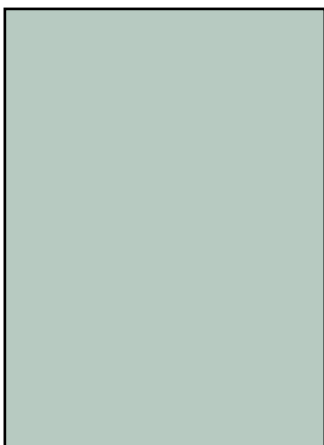

Xikinpoua keski flakilome kate ijtik sejse
chatanajtli iuan xikijkuilo ijtik
flatsakualtsitsinti.

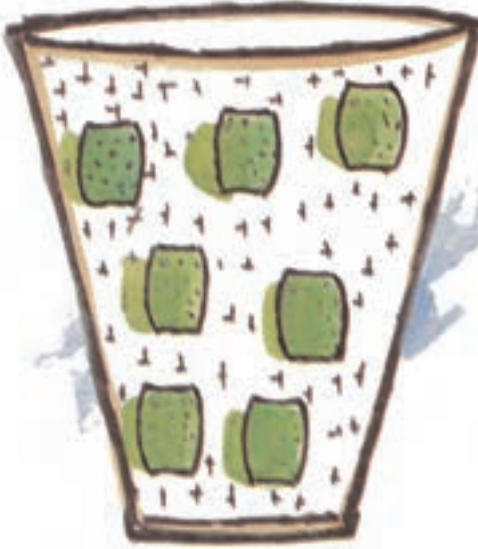

nochtli

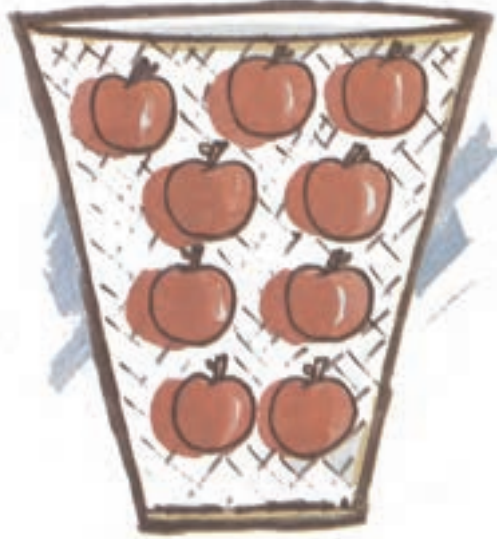

masanox

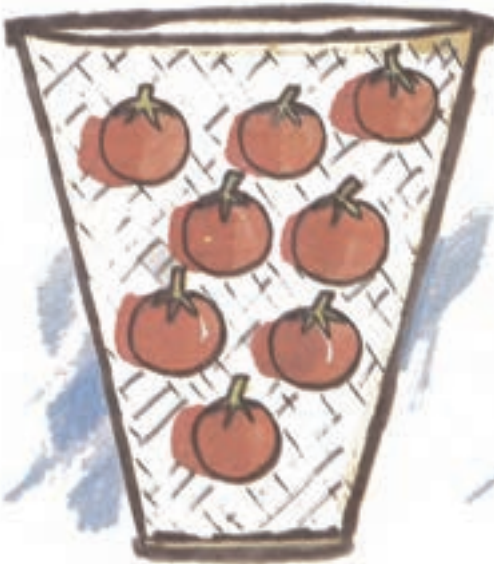

xitomatli



tsapotli

NAUJPA AMATLAXELOLI



Totlaixmatij kayotl.

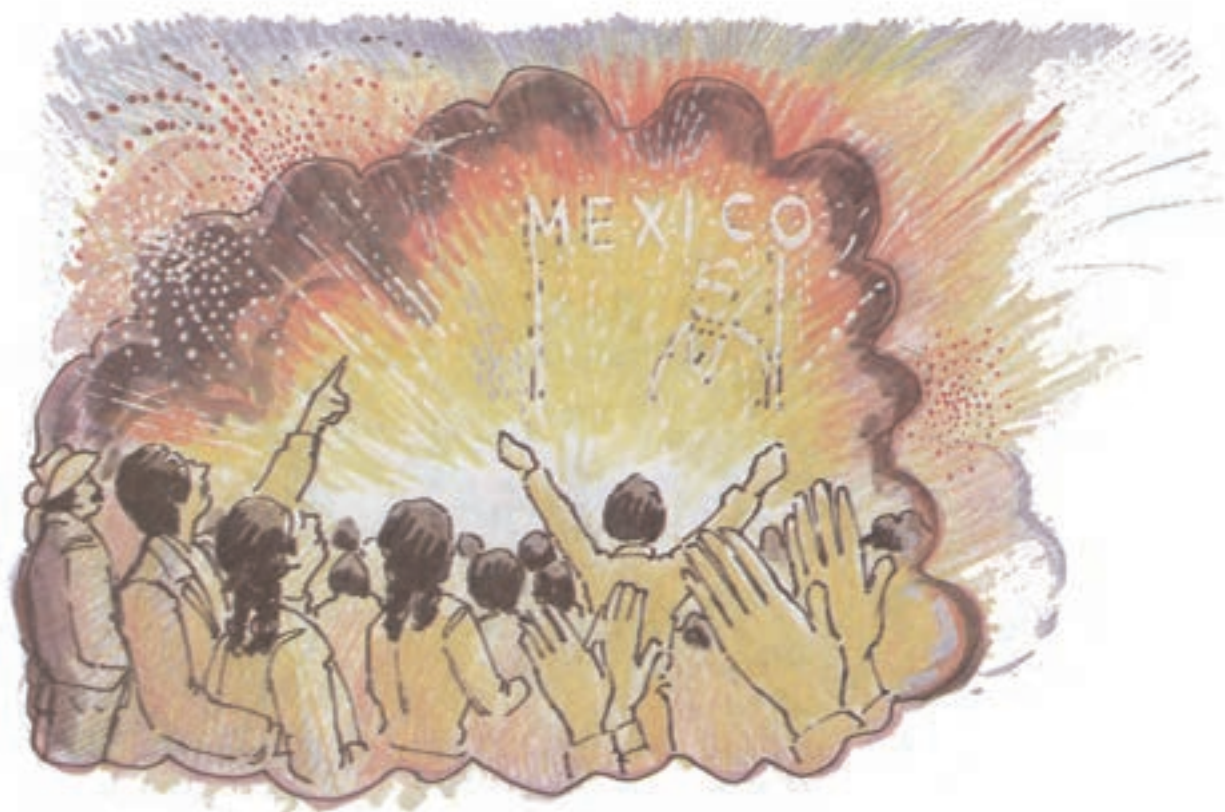



MIEK ILJUITL TIKCHIUVA ITECH TOMASEUAL ALTEPEUA



Ijkuak tialtepeiljuichiuva, mijtotia tilitliltike, tikintlatia auilme, onka mijtotilo iuan miek okseki tlamantli.



Tonanantsitsiua nuijki tikinchiuilia se ueyi iljuitl pampa yejua techmaka toyoliskayotl.



Tikiljuikixtia topantli pampa ye kineskayotia nochi tomexko tlalpa.



Tikimilnamiki nochi tlen yotechkajtejke iuan oasito ompa miktla kanin tejua se tonali iuan timonechikoske.



ALTEPEILJUITL

Itech ni altepetl ijkuak tikchiua ye altepeiljuitl miek tipaki tinochti. Onka miek chiualo. Mieke tlakame tlen ejko nika uitse ompa ixtlauak kinemakakiui miek tlamantli: tilmajti, petlame, koskame, xoktsime iuan miek okachi tlamantli tlen tejua tikoua ika miek pakilistli. Nuijki mijtotia titliltike, tikintlata mieke auilme, tiaui teopankalijtik timotlasojkamatitui iuan mieke telpokame yai mijtotitui ompa kani kichiua mijtotilo.

**Nika xiknexti katliye iljuitl okachi tikuelita
ian xikchiua se tlajtoltlayejyekoli.**

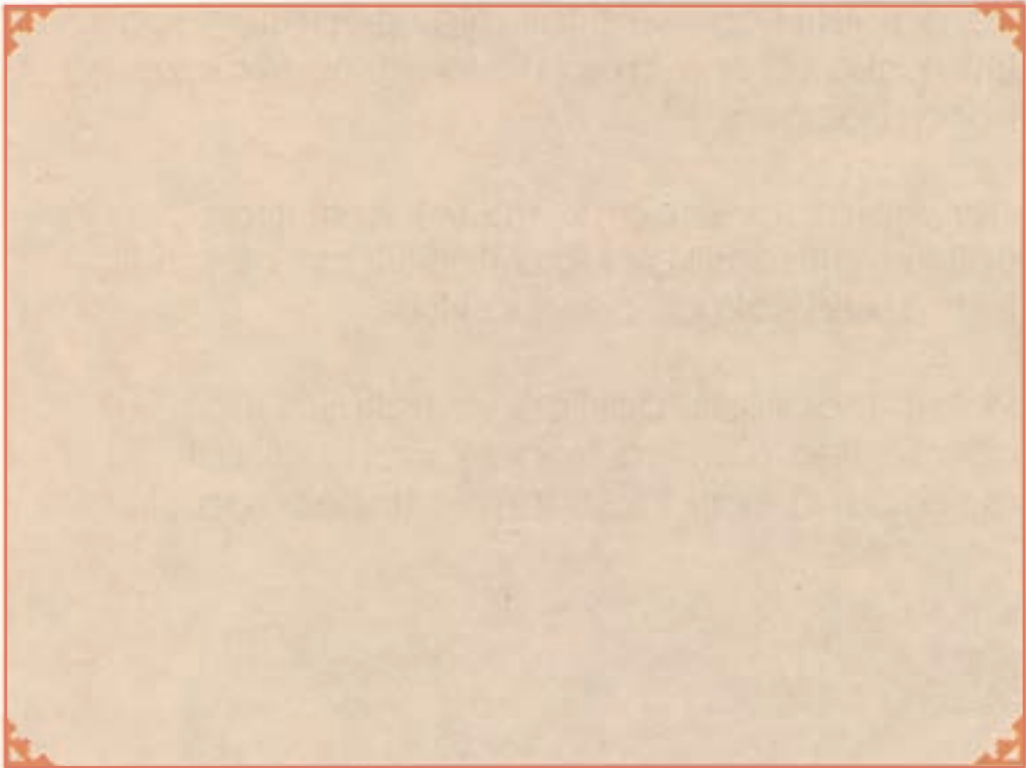

PAKILISTLI

Ye pakilistli kemi se sitlali miek pepetlani iuan kitemaka totonik axka noyolo tsopelik ejko ika itonal nechtlauilia.

Tlen kipia pakilistli amo yolitok iselti ipan yoliskayotl semijkak kipia tlauli iuan ejekauilis iuan se tlatsakuali pampa kisas.

Pakilistli, pakilistli, pakilistli ye tlakuika ipan noyolo tlen ejko ika tsopelik iuan pakilistli motlapoua iuan kikisa kemin tlatiochiualistli.

C.F



Nochti omejua xikxitinika ni xochitl iuan
xiktlalika ijtik xikaltsintli

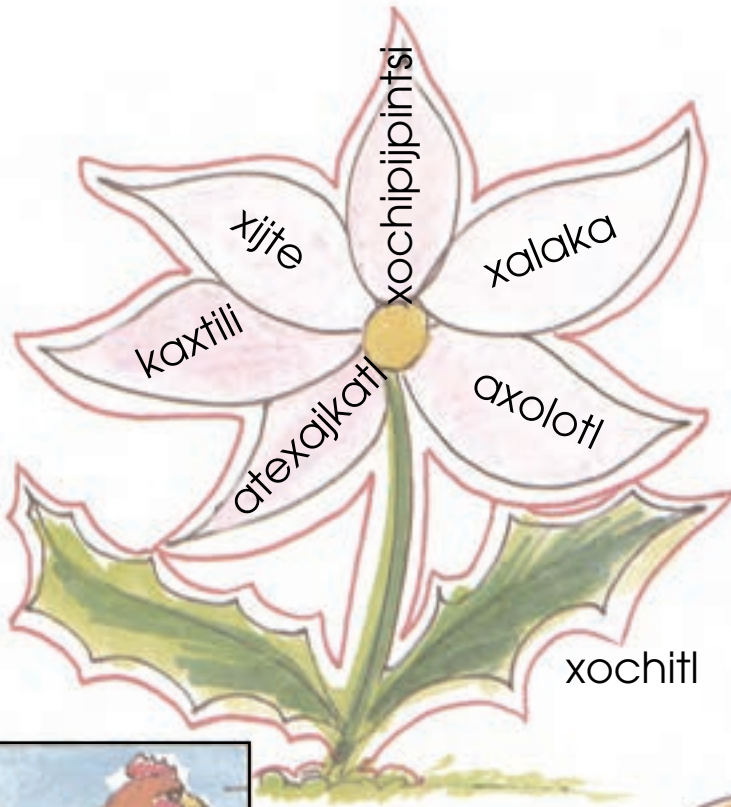

Ni misto kinkitskis nocti kimichime,
omejua xikinkalakika ijtik se
kalkimichkitskilos.



astili

sintli

oselotl

astotl

masatl

sayolin

Nocti yolkame xikinkalaki ijtik
tlatsakuali iuan tlakilome xikintlali ijtik
chatanajtli.

astotl



oselotl

masatl



xonakatl



xokotl

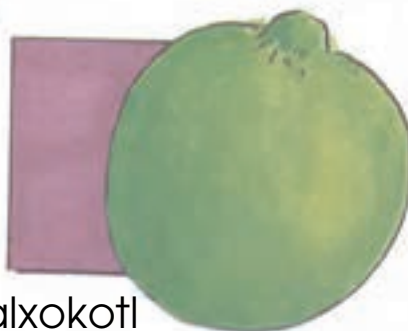

xalxokotl



Ika nime tlajtolme xikinchiua sekime
tlasentiltlajtolme.

axolotl

xalaka

sintli

astotl

kaxtili

sayoli

- 1 _____
- 2 _____
- 3 _____
- 4 _____
- 5 _____
- 6 _____



**Xikpoua ni amatlajkuiloli iuan
ximotlapoui iuan oksekime koneme tlani
onkitilijke iuan tlani amo.**

AMATLAJKUILOLI

Xitlama, sokitla kuetlaxkoapa
flatskitok ipan se tonali mayo
tlen 1995.

nochokotsi Xokoyotsin

Nika nimitskajteuilia ni
amatlajkuiloli; kenomi amo nika
otikatka, amo ouelik onimitsiljui
nikomokuateki ikone mokni
iuan onia ikaiijtik pampa okichi
se iljuitsintli.

Tiatikneki xiuike tiamo techia.
Monantsin

Yoloxochitl

**Tlaxe monantsin mitskajteuilia ni
amatlajkuiloli te kenomi otiknankiliskia.
Nika xikijkuilo.**

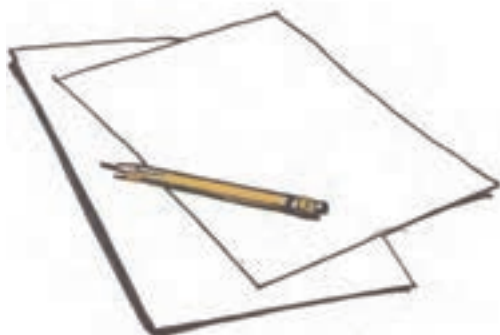
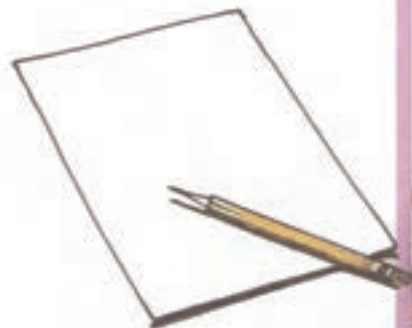



TLÉN KICHUUA TOMASEUALIKNIUA

Tomaseualikniua pampa uelitis monekuitlauiske kitekipanoua miek tlamantli; kinchijchiua, petlame, xoktsime, komalti, tanajti, kuaejekauilolme, chikime ika akatl iuan tilmajti ika ichkatl.

Nochti yejua ijkuak tekipanoua paktoke pampa yejua kiyeyjekoua nikijkuak tekipanoua kitlani itomintsi iuan ijko amo apismikiske.

Ualeua amo kinemaka tlen kichuua pampa kiuelita tlapatlaske. Yau i tech miek altepeme kani onka miek tlakilo iuan kanin onkate iljuitsitsinti iuan ompa tlapatlatiui.

Xilonen



**Ijtik nime flaixnextilme kate sekime
flaijtlanilisme te xikinankili.**

¿tlaní kitlaní
tomaseualikniua
ijkuak kinemaka
nochi tlen kichiua?

¿tlaní ika
kinchijchiua
chikime?



¿tlaní ika kinchiua
tilmajti?

¿ijkuak amo kinemaka tlaní
okseki kichiua?

Ni tlakatsintli okojkouito; itech sejse kouitl kajki se tokayotl te xikinpanolti kani kate flaixnextilme ipan koujtsitsinti.



tlachpanoni

tochin

ichkatl

chili

chompetla

chikiuitl



Ijtik tlatsakualme xikinpanolti tokayome
tlen kate itech masanoxti iuan xikinchiuili
intlaixnextilis.

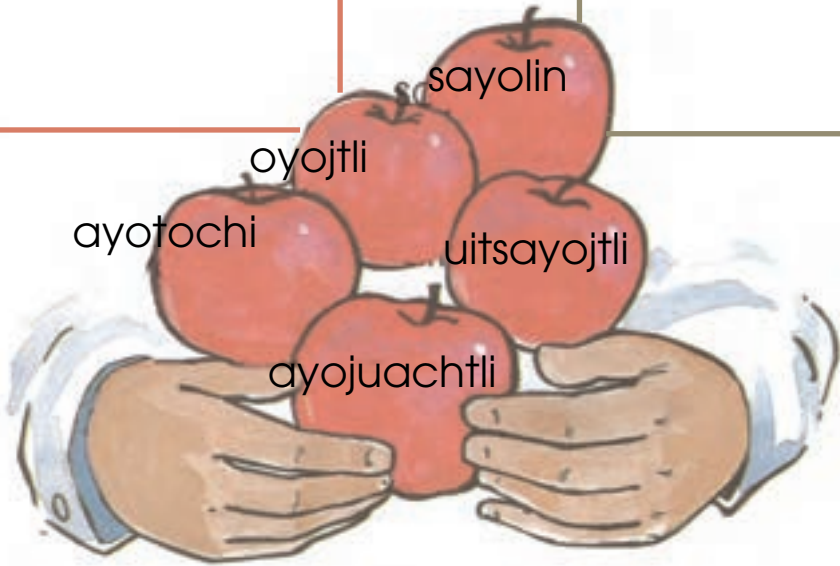
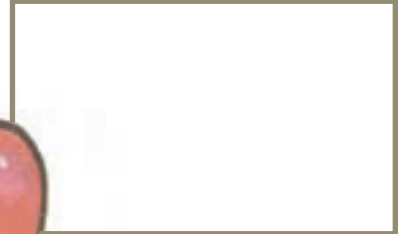

Xikimaxiti flasentiltlajtolme ika tlen kinemakatoke suatl iuan tlakatl.



- Tlakatl okiko se _____ pampa kineki makichiuilika itilma,
- Suatl otiankesoto iuan okiko _____, _____, _____ iuan _____.
- Se chokotsi okinechiko miek atl iuan okikouato se _____ iuan ampo okikalaki.
- Se takotsi otlajpiato iuan opanok kanin okinemakaya sekime yolkame iuan ye okiuelitak se _____ iuan okiko.



KEN TIMOPAJTIA

Nochti tejua timaseualti ijkuak timokokoua timopajtia ika maseualpajtli. Ijkuak aka ejekauilo sanima mopopochjuia ika miek uakxiuitl. Se konetl ijkuak momojmoujtia motsajtsilia ika amoujtilistli. Siuame ijkuak tlakatis ikone nuijki kimaka maseualpajtli pampa uelitis tetlakatilis. Nochi, nochi, tlen techkokoua tikpajtia ika maseualpajtli. Iuan kate tlakame iuan siuame tlen tepajtia iuan tikimixmati kenomi pajtlatamini. Kate tepachojke, tetsajtsilijke, tisitl, tlachixke iuan oksekime tepajtijke. Ualeua nuijki tikoni koyopajtli ijkuak kani tichanti onka kaltepajtilistli.

Xilonen

Te xikpitsa ni kuakoujtli iuan kisaske
mieke kokolistflajtolme; xikinpejpena
iuan xikinkalaki ijtik kuaejekauilolme.

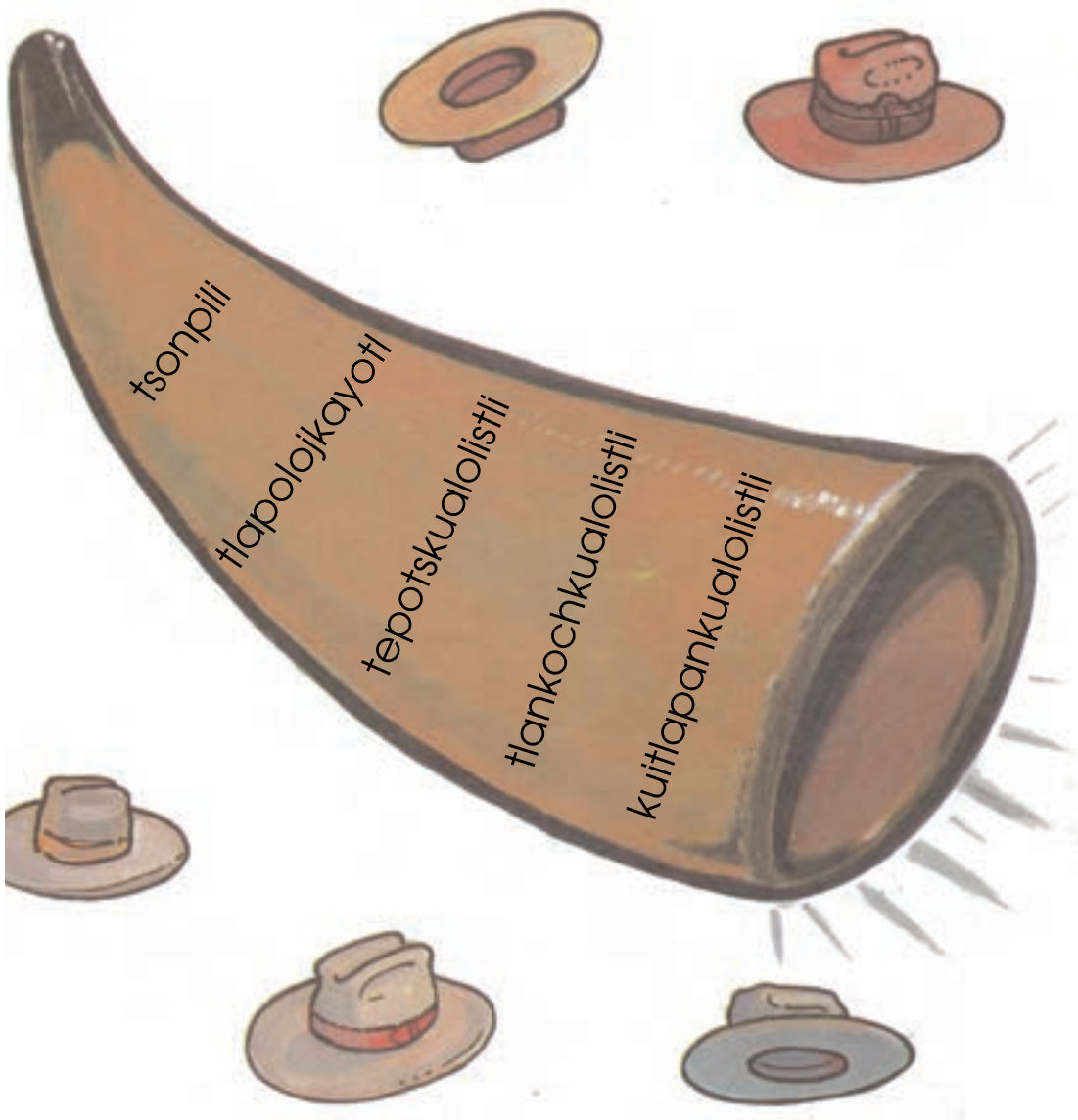

Nika timitsintlalilia sekime flaixnextilme te ximauilti xikinpanolti ijtik flatsakualme ompa kate intoka.

tlalchichinoli	kuauino	xonakatl
axox	xiujtlachichinali	nojipali



KOKOLISMAUITILIS

Ye Xokoyotsi kikokoua itsonteko
¿kani, kani, kikokoua? itsonteko
¿tlani ika tikpajtiske? ika yoyojtli
iuan tlakonili. ¿tikualpiske?
kema, kema.

Ye Xilonen tlankualo ¿kani kani
kikokoua? itlantsi ¿tlani ika
tikpajtiske? tikpajtiske ika
xiujtlachichinali, ¿tiktlaliliske ijtik
itlantsi? kema, kema, ompa
tiktlaliliske.

Ye Akoxti totonkamiki ¿kani, kani
kikokoua? kipia totonik ¿tlani ika
tikpajtiske.
ika tlakonili tikaltiske ¿tikaltiske?
kema, kema tikaltiske.

Xilonen

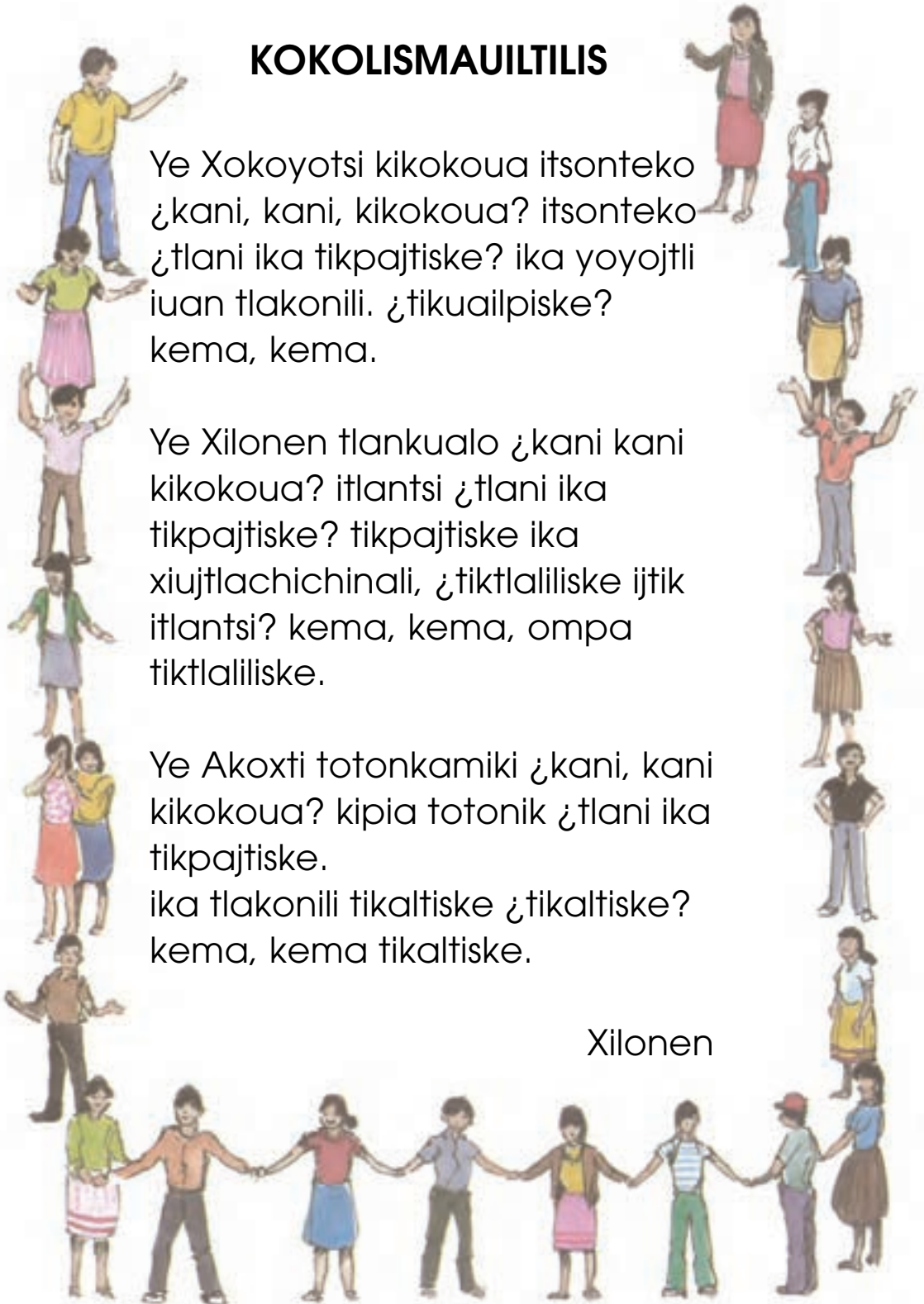

**Nika kate sekime flajtlanilome te
xikinankili tlani.**



Kokok iuan amo chili
mitsajtsitia iuan amo mitsmaka
tiktlalilia motlakual
iuan tikuelilia miek.
¿tlani?

(xonkati)

Sekime tikinkua
sekime mitspajtia
iuan sekime
tlamo tikimixmati
mitskuaxiuintia

¿akime?

(nanakame)



Xilonen

Ika nime tlajtolme te xikinchiua sekime
tlasentiltlajtolme.

1 _____

2 _____

3 _____

4 _____

5 _____

6 _____

Kuauino

xonakatl

popochtli

tsonpili

nakaskualolistli

tepotskualolistli



TOCHIME

Itech se altepetl uejka, uejka, okipiaya inkalijtik sekime tlakame tlen omotokayonotsaya kastro, nin tlakame okipiaya se ueyi tochi, iuan se tonali tlakatl okiljui itena tiaske tipaxialotitui xikinyektlali totsotsoljua pampa orne noso eyi tonali ompa timokauaske. Tenantsi flauel okintlasojtlaya yolkame -okijto- axka nikuikas ye tochi iuan opejki kaltia.

Oasik tonali iuan okiske opaxialoto; ye tochi okitlalilijke se kuajkualtsi itsotsol ijkuak oasito ipan ueyi altepetl opaxialoto kani kate mieke yolkame, ye tochi akiuelitak se siuatochintsi iuan ijkuak oasik tonali oualmokopke iuan tochi amo okouala pampa okineki mokauas iuan siuatochi.

tenantsi omotekipacho miek ijkuak oejkoke itech ialtepe iuan okijto: ijkuak oksejpa nechuikaske pampa nipaxialoti amo nikuikas okse noyolka.

Okijkuilo Temachtijketl:

Adrian Soriano Figueroa

**Nika timitstajtlania seki tlamantli te
xitlanankili, nochi kajki itech
tlajtolpoualistli.**

¿Kenomi omotokayotiaya tlakame?

¿Tlen yolkatsintli okipiaya nime tlakame?

¿Tochintsi akini okiuelitak?

¿Kanin opaxialoto tiani okimitake?

¿Akin iuan omoka tochintsi?

Nika timitsintlalilia sekime flaixnextilme te xikijto kenomi ueli tikintokayotia.









YOLISKAYOTL (Xochitlajtoli)

Yoliskayotl se kuali
teotlachiuali tlen toteo
otechmakak Tlen ixnaltik
kineki tlachias koxo kineki
nejnemis tlen apismiki
kineki tlakuas iuan tlen
yoixpoliuk kineki
moyolkuis.

Ijko ne nomechiljuia
xiknankilika pampa kuali
poso amo amo okse
fikpiaske.

Okonchi: Adrian Soriano Figueroa







**Nika xiknexti nochi tlen okitlalijke itech
flamanali iuan xikintlalili intoka.**

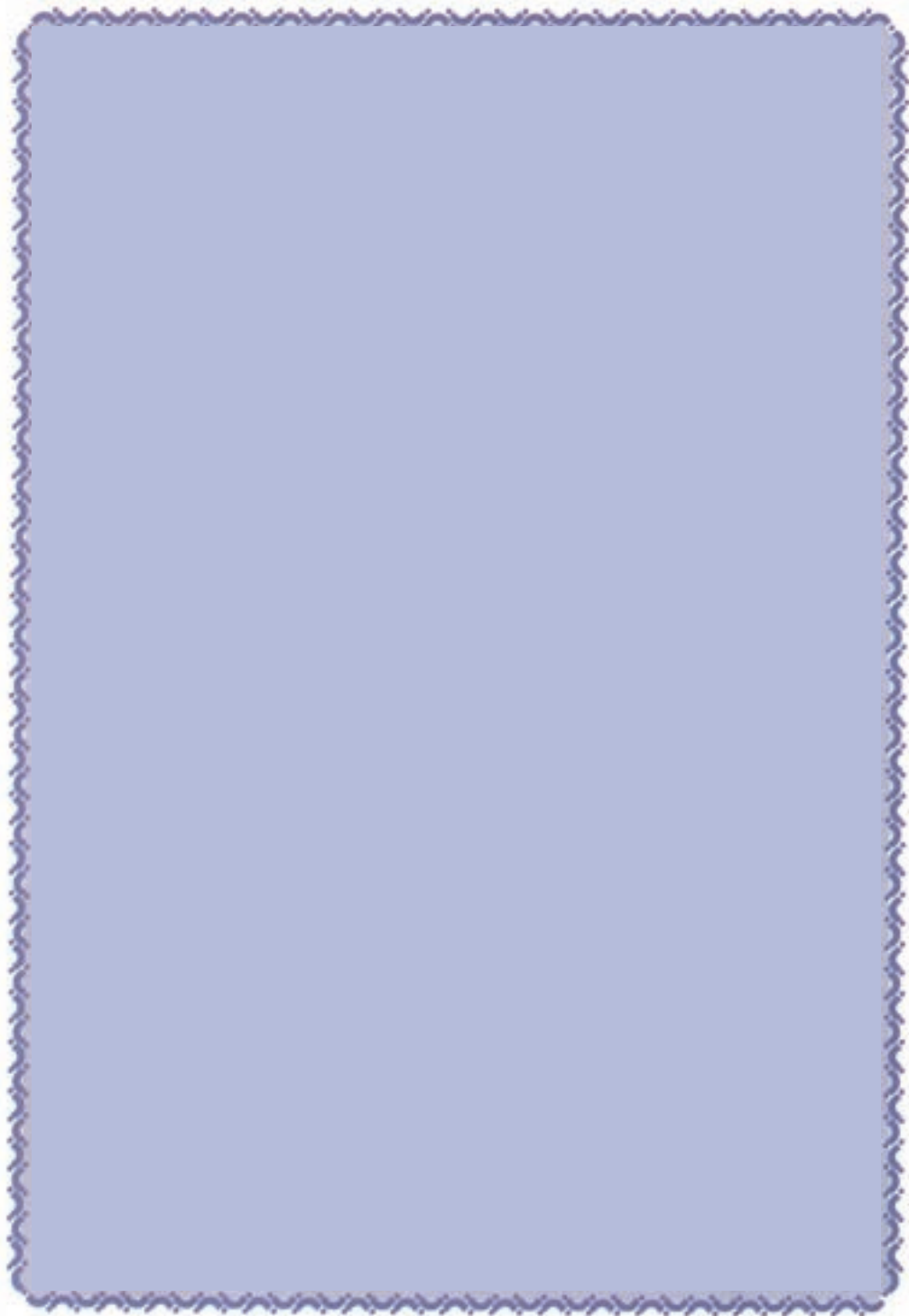

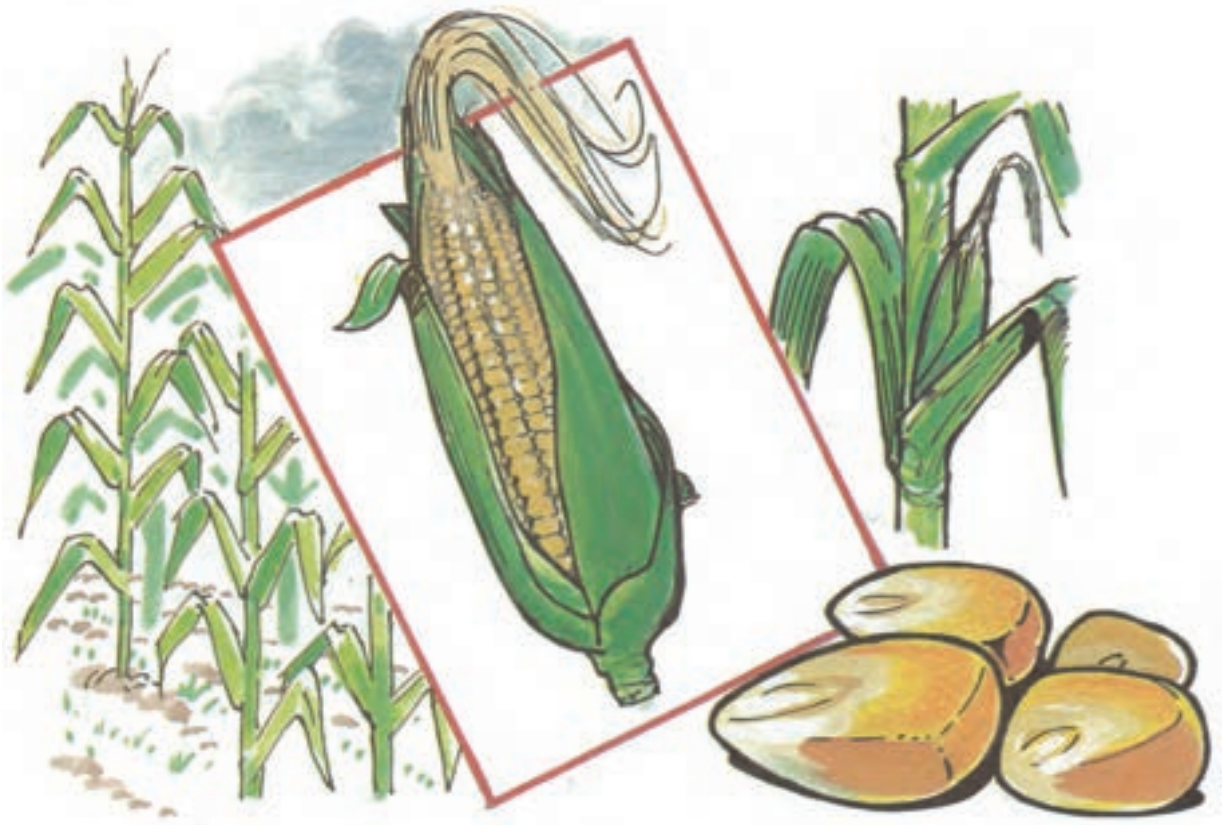

KANI OMONEXTI TLAYOLI

Tokojkoljua kipoua ye tlayoitsintli tlen ika tejua timotlakualtia yikinika omonexti tiaijtik in se ostotl. Ni mokaua itech se aitepetl itoka koskatla.

Ni altepetl mokaua kani peua ixtlauak; itlakaua amo ueliti tiapoua ika tomaseualtlajtöl maski mieke tlen tomaseualikniua tlen pala icha ompa omokaitito iuan yejua kimati tiapouaske ika mexijkatl iuan ika kastiya tlajtoli.

Itech mili kate sekime tlajtolme te
xikinteki iuan xikintekpana ipan
mekatsintli pampa uelis tikimilpis.

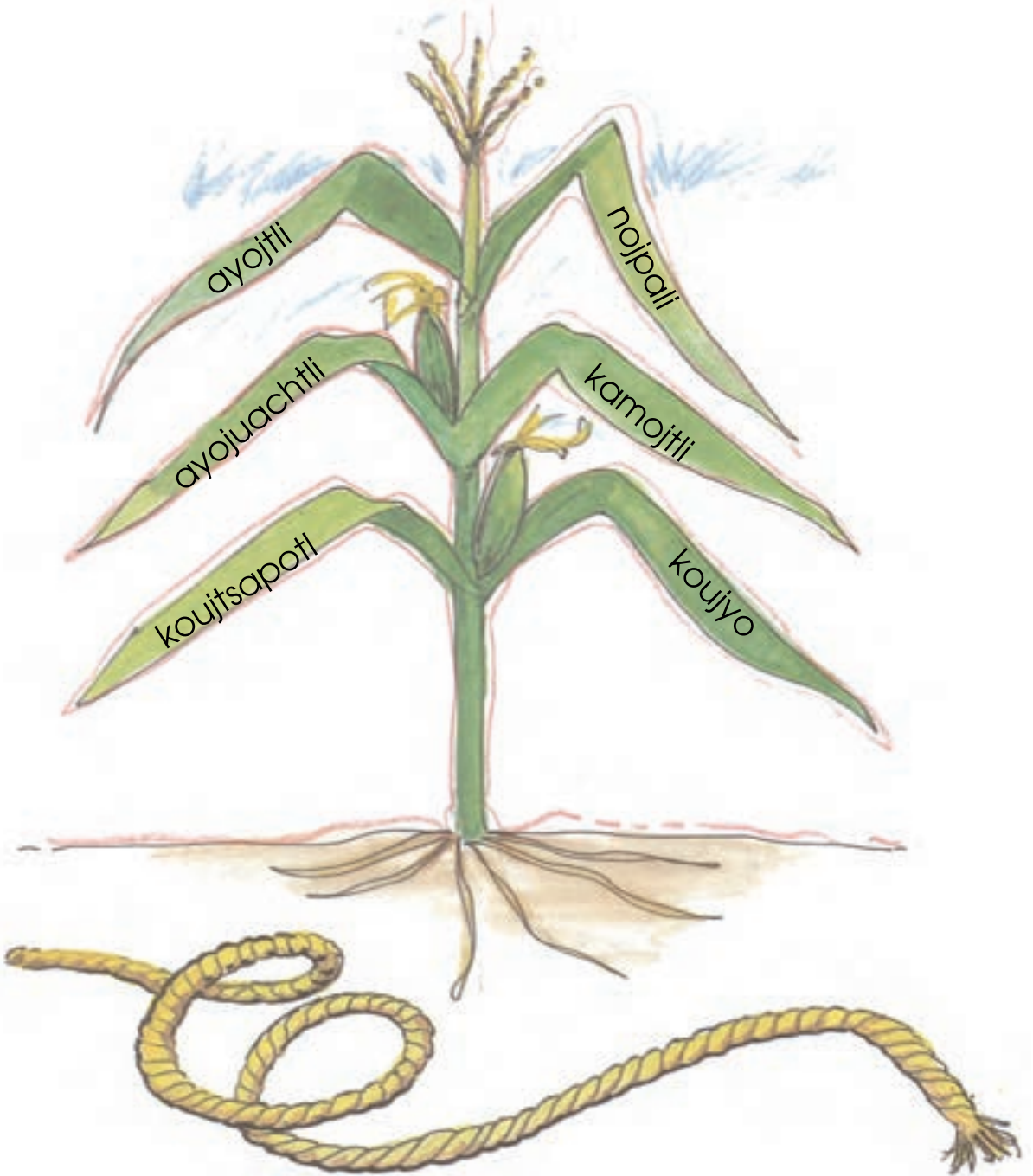

**Tlakpak timitsintlalilia sekime
flaixnextilme iuan tlalchi intoka; te
xikinpanoltli intoka ipan koujtsitsinti.**



ayojtli

nojпали

ayujuachtli

kamojtli

koujtsapotl

koujyo

**Nika timitsintlalilia ome
flajtolnenepantlamilis xikinpoua iuan
xikinchiua oksekime iuan
motemachtijketl.**

TLAJTOLNENEPANTLAMILIS

Ijkkuak yau i pan ojtli
se konetl motlakentia
pampa kikuajtiuj se
kamojtli iuan amo
techyekoltia.



Takotsi tlen i pan ojtli tiuits
takotsi tlen techpaktia
nikneki semijkak tiuits
pampa noyolo tikpakiltia.

okinchi: Xilonen

Omejua xikchiuaka nochi tlen kijta ni tlajtoltlayejyekoli..

ITSKUINTLI IUAN SIUAPIO

Itech se maseualaltepetl onka miek yolkame kemi ueuejchome, kaxtilme, itskuinti, mistome, ichkame iuan oksekime yolkame.

Se tonali otechtlapoui se ton·nantsin, nikokinpiaya miek kaxtilme iuan kijta se tonali ye siuapio onejnemia ika iyolika kiauak pampa se ijkinsi omonamike iuan se itskuintli axka peua motlapouia pampa kiljuia santikneltoka mamitskuaka, ye siuapio okinankili ika kualankilistli te tikneki manechkuaka pampa te tikyecos nonakau iuan omitl tikuas.

Axka ne nimitsiljuis itskuintli ne nika nietos pampa niktalis teuksistli iuan notekoua kimati kemia nechkuaske.

Axka momostla tonali ye siuapio kisa iuan yau paxialoti. Se tonali omonamiki iuan itotata kaxtili iuan okitlapoui tiani okipanok iuan ye okinankili amo xikneltoka tlen mitsiljuia; ye itskuintli sailiuis tlatsiujki iuan apismiktok kineki nuijki kikuas tonakau pampa ye kikua nochi tlaxkaluaki iuan kineki kikuas seki kaxtilnakatl.

Ni tlajkuiloli kijtosneki: amo se kineltokas nochi tlen techiljuia noso techtlapouia moneki tejua tikitaski ika toixtololoua.

**Nika xikimixnextika iuan xikijtoka flani
okachi onkiuelitake flen onkichijke.**

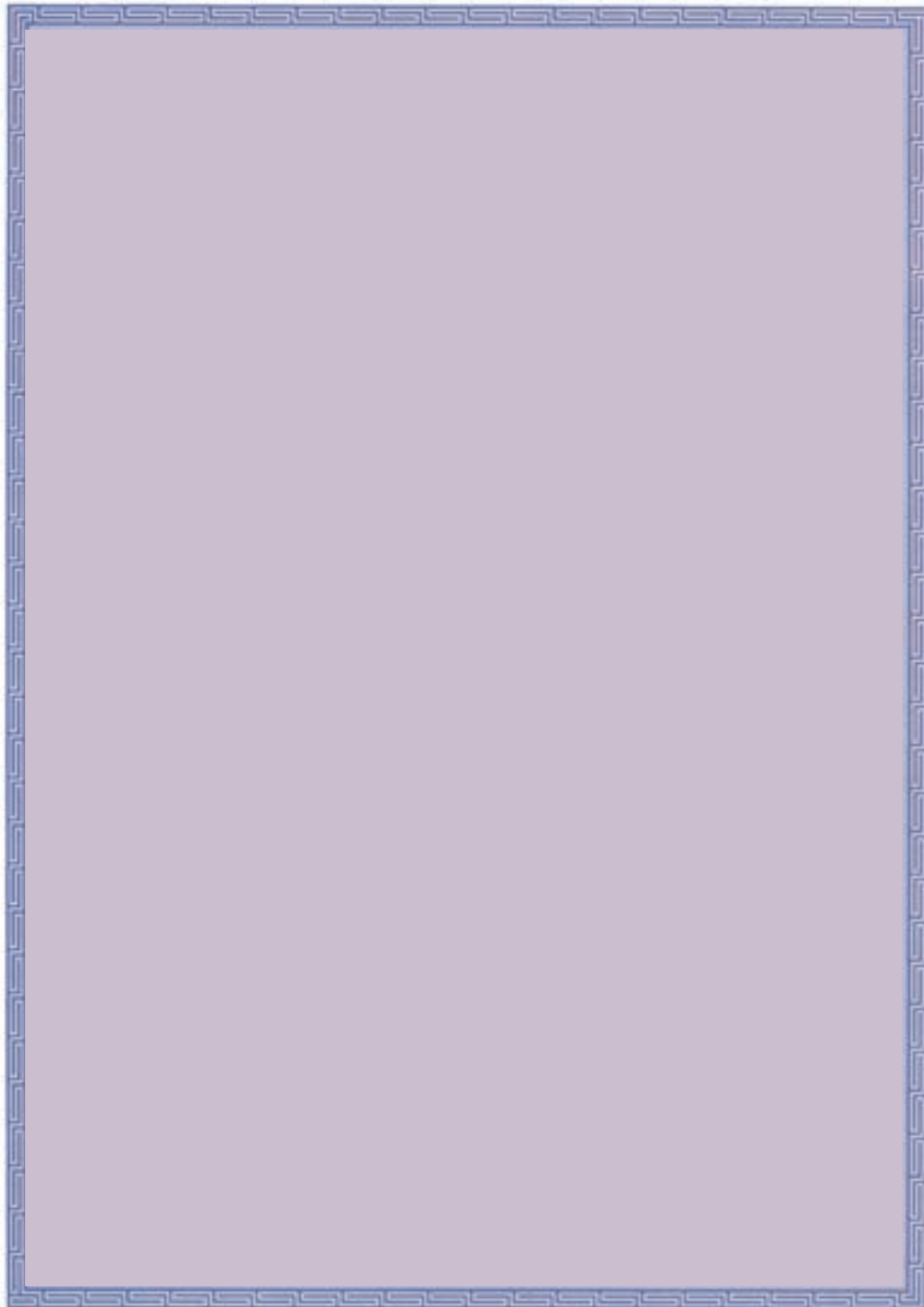

KENOMI OMOMACHTIAYA TONAUAMASEUALIKNIUA

Ijkuak amo yoejkouaya yejua pinome tlen motokayotia españolti tonauamaseualikniua okimomachtiaya nochi ompa iuan itataua iuan itech kaltlamachtiloyan.

Chokojti okimomachtiaya inkaiijtik iuan itajtsin flakojkouske, flapechximaske, michtlakitskiske iuan koujtlapanaske.

Takome okimomachtiaya inkalijtik iuan inantsin, ye okimititiaya kikuechoske nextamali, flaxkaloske, flajtsomaske pampa yejua okinekia yetoske ichpokaua kuali siuame ijkuak monamiktiske iuan kuali tename ijkuak kinpiaske inpiljua.

Intetajua kuali okintlapouiaya, okimiljuiaya kuali xikitaka omotetajua, amo xitlananankilika pampa tlamo onmouika kuali, tlamo onkitoka se kuali ojtli amo onyetoske kuali tlakame satepa, pampa onmopoloske iuan amo onyetoske kuali iuan ika pakilistli pampa omopa uetsis ye tekipacholi.

Ijkuak itla amo okichiuaya kuali okinmakaya, okintsopitiaya ika mexkaluitstli, iuan okitlaliaya makinejnekuika pokchili.

Okatka ome kaltlamachtiloyan ye kaimekak iuan telpochkali. Itech inkalmekak omomachtiaya yejua ipiljua ueyi tlanauatiani iuan itech telpochkali omomachtiaya ipiljua yejua maseualti.

Xilonen

Nika xikijto flani tikua itech se tonali.

Kualkantsi _____

Tiotlaksintli _____

Youaktsintli _____

**Te xikinexti sekime ikxitsitsinti iuan xikijto
kani iktias pampa uelitis tejkos okse
altepetl.**





TLAIXNEXTILISTLI

Se telpochtli ijkuak kiuelita se ichpochtli, peua kitlapouia, iuan ijkuak okachi yimoixmati ye telpochtli kiljuia ichpochtli tlaokinekiskia yetos inamik; tlaye ichpochtli kijtousa amo ye telpochtli kikaua iuan tlaye ichpochtli kijta kuali kajki, ijkuako ye telpochtli kimaka itsonkalilpilo, ixiljuas iuan ixnexteskatli; ijkuak kiselia kijtosneki yikinankilijtok iuan uelis kitlajtlanitui.

Xilonen

TLAIJTLANILISTLI

Ijkuak se telpochtli kineki monamiktis sanima kimiljuia itataua iuan yejua yau i kimitatiui intataua ye ichpochtli. Akime tlayekana ye kojkoltsin iuan sintsintli pampa yejua kipia se ueyi tlajtoltlamatilis.

Kema yau i tlanjlanitiui kiuka se ueyi chikiuitl iuan kitemitia ika tsopeltlaxkali, chokolatl, tlakonili iuan tiachichinali. Ijkuak yikinika yau kimiljuia mamochiaka pampa moneki motlapouiske yejua iuan ichpochtli; kimiljuia maoksejpa ualaka ipan kaxtoli noso senpoali tonali iuan ijkuako kimatitiui tiani omotlapouijke. Ijko yejua oksejpa yau ipan tonali tlen okimiljuijke; ijkuako oksejpa kiuka okse chikiuitl tentok iuan kitemitia ika nochi tlen achto okitemitijke. Itech ni tonali kimiljuia nikyomotlapouijke iuan yokijtojke kual i kajki mamonamiktika iuan moneki oksejpa maualaka ipan kaxtoli noso sempoali tonali pampa kitlaliske tonali kemia monamiktiske iuan tlani kichiuaske itech iljuiti.

Xilonen





NAMIKTILISTLI

Ijkuak monamiktia achto kitlachijchiuilia totajtsi iuan iyekapantsi kipopoxjuia ye ichpochtli; nochtli panoua ye isitsin, ikojkoltsin, itataujtsitsiua iua'n oksekime iteixmajtikaua.

Mochiua miek tlakuali: ye ueuejcho ika moli, xokotamali ejeyojtamali, etl, chilkalto tlen kichijchiua ika ichkanakatl iuan miek tlakonili.

Tlen monamiktia, kintekilia itlakual ijtik se kaxitl kanin yejua orne moseitltlakualtia pampa kijtoua tokojkoltsitsiua ijko okachi moyekuikaske satepa.

Xilonen

**Xikintlali nika sekime tlen monamiktijtoke
iuan xikijkuilo ipan koujtsitsinti kenomi
monamiktia ompa moaltepe.**





KEN ONESKI TENOCHTITLA ALTEPETL

Ichimal tlen kipia topantli kichiua oksejpa matikilnamikika ken oneski ye ueyi altepetl tenochtitla ipan ni tomexko tlalpa.

Techpouilia se tlajtolnemilis nikyejua astekatlakame oyaya nejnentiui pampa okitemojtijiaya ye iteotl Uitsilopoxtli, yejua okinekia makimiljui kanin kichiuaskia iteopa iuan ikaljua.

Oejkoke kani okatka metsamanali iuan ompa, itech se islotl okitake se kuautli ken ompa oloseui iuan omoketski ipan se nojpali. Okikuajtoka se kouatl.

Astekatlakame okimatke nikyejo okichiaya; omopakiltijke, omoketske iuan ompa opejke kichiua ni ueyi altepetl.



INETLAKATILIS YE BENITO JUÁREZ

Senpoali iuan se tonali tlen eyi metstli
motokayotia marzo ipan naui tsonitli iuan
majtlakpoali iuan chikuase xiuitl.

Ipan senpoali iuan se tonali tlen eyi metstli
motokayotia marzo tikiljuichiu itlakatilis ye tlakatl
tlen opanok ken se ueyi tlanauatiani ipan ni
tomexko tlapa itoka Benito Juárez.

Ni ueyi tlakatl Benito Juárez okitak nochtli
altepeme mamoyekuikaka iuan nochtli tlakame
nuijki.



TLATEUILO IUAN TLASENTILISTLI IPAN NI TOMEXKO TLALPA

Kaxtoli iuan se tonali tlen chiknaujpa metstli tlen motokayotia septiembre ipan naui tsontli iuan majtlakpoali iuan majtlaktli xiuitl.

Ipan miek xiuitl tomexko tlalpa okinauatiaya yejua koyome tlen nika omotlaliko tlen motokayotia españolme.

Miguel Hidalgo iuan oksekime tlakame okinekia matiyekyetoka. Ijkuak yikintlanestok ipan kaxtoli iuan se tonali tlen chiknaujpa metstli tlen motokayotia Septiembre Miguel Hidalgo okinechiko mieke tlakame tlen ochantia ipan Dolores altepetl iuan okimiljui mamosetilika iuan mamoi xpantika iuan koyome pampa uelitis kinkixtiliske nochi tlen yejua imaxka.

Ijko opejki ni tlateuilo ipan ni tomexko tlalpa iuan totlasentiliskayotl.



TLEN KINESKAYOTIA TOMEXKO TLALPA

Nohti tlen titlakati ipan ni mexko tlalpa,
timotokayotia Mexijkame.

Chimali, pantli iuan tomexko tlalpa tlakuikali
kineskayotia tomexko tlalpa.

Nuijki kineskayotia tlen okachi tiktiasojtla ipan ni
totlalpa iuan totonalnemilistli.



TOMEXKO TLALPA TLAKUIKALI

Mexijkame xiuiki xitlamaki
xikpixtoka tepos iuan yolkame
tlauiuikas tlatlajko tlaltikpak
ualnauatis tepostlatopon.

Kiyevalos xiuitl totlaltikpak
tlayolseuis inyeltsin yetika
iljuikak amo kema timikis
ika imajpil toteo okijkuilo.

tlamixeui okse amo mokni
tlaltsaki kani temo tlaltikpak
xikmati otlaso tlaltikpak iljuikak
se tiamani omitskajteuili.

Okijkuilo ika Koyotlajtoli:
Francisco González Bocanegra



ITONAL IN PANTLI

Senpoali iuan naui tonali tlen ojpa metstli tlen motokayotia Febrero.

Pantli kineskayotia tomexko tlalpa, totiakaua, totlaltsin iuan toatsitsiua ijko tikijtoua nikye ineskayotilis tomexko tlalpa,

Ipan senpoali iuan naui tonali tlen ojpa metstli (febrero) nohti mexijkame tikiljuikixtia topantli.

